

CATALOGUE/CATÁLOGO

METAL CUTTING  
CORTE METAL

GRINDING - POLISHING  
LIJADORAS - ESMERILADORAS

WOOD AND ALU CUTTING  
CORTE DE MADERA Y ALUMINIO

20  
24



A WORLD OF PERFORMANCE



**A WORLD OF PERFORMANCE**

**FEMI SpA is an Italian company that after fifty-seven years of history keeps unchanged the will to be a reference brand in the world of machines intended for professionals users.**

**Our mission is the continuous search for novelties and best solutions to design and produce innovating, safe and high-quality products. Year by year, FEMI brand has known how to renew itself by offering efficient and innovative solutions for those who want the best tool to work in a precise and safe way or even just for those who want to build with their own hands and their creativity the objects of daily life.**

**FEMI es una empresa italiana que, después cincuenta y siete años de historia, mantiene la voluntad de ser una marca de referencia en el mundo de las máquinas destinadas al trabajo de profesionales. Nuestra misión es la búsqueda continua de novedades y la mejor solución para diseñar y construir productos de vanguardia, seguros y de alta calidad. Con el tiempo, la marca FEMI ha sabido renovarse ofreciendo soluciones eficaces e innovadoras para aquellos que quieren lo mejor para trabajar de una manera precisa y segura aunque sea para aquellos que quieren construir su propias manos y con su creatividad los objetos de la vida cotidiana.**

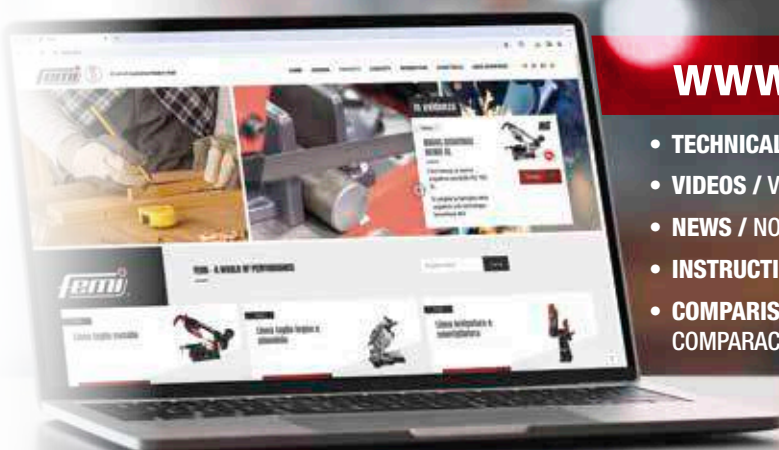

**www.femi.it**



- **TECHNICAL DATA SHEETS / FICHAS TÉCNICAS**
- **VIDEOS / VIDEOS**
- **NEWS / NOVEDAD**
- **INSTRUCTION MANUALS / MANUALES DE INSTRUCCIONES**
- **COMPARISON OF PRODUCTS FOR THE RIGHT CHOICE / COMPARACIÓN DE PRODUCTOS PARA LA ELECCIÓN CORRECTA**

## METAL CUTTING LINE / LÍNEA CORTE METAL

<b>BANDSAWS - INDUSTRIAL RANGE</b> SIERRAS DE CINTA INDUSTRIALES	2
<b>ACCESSORIES - INDUSTRIAL RANGE</b> ACCESORIOS - SERIE INDUSTRIAL	16
<b>HANGING FLEXIBLE SYSTEM</b> EQUIPO FLEXIBLE PÉNSIL	17
<b>BIMETAL BANDSAWS BLADES - INDUSTRIAL RANGE</b> HOJAS DE CINTA BIMETÁLICAS - SERIE INDUSTRIAL	18
<b>BANDSAWS PROFESSIONAL RANGE</b> SIERRAS DE CINTA PROFESIONALES	20
<b>ACCESSORIES - PROFESSIONAL RANGE</b> ACCESORIOS - SERIE PROFESIONAL	38
<b>BIMETAL BANDSAW BLADES - PROFESSIONAL RANGE</b> HOJAS DE CINTA BIMETÁLICAS - SERIE PROFESIONAL	40

## GRINDING - POLISHING LINE / LÍNEA LIJADORAS - ESMERILADORAS

<b>BELT SANDERS - INDUSTRIAL RANGE</b> LIJADORAS DE BANDA INDUSTRIALES	42
<b>BENCH GRINDERS</b> ESMERILADORAS	49
<b>SHARPENING MACHINES</b> AFILADORAS	57
<b>ACCESSORIES</b> ACCESORIOS	58
<b>GRINDING WHEELS, BRUSHES AND BELTS</b> MUELAS, CEPILLOS Y BANDAS	60

## WOOD LINE / LINEA MADERA

<b>MITRESAWS</b> TRONZADORAS DE MADERA	62
<b>CIRCULAR BLADES</b> DISCOS	74
<b>ACCESSORIES</b> ACCESORIOS	76

## DISPLAYS

2700 LINE / LÍNEA 2700

2600 LINE / LÍNEA 2600

THREE-PHASE WITH  
AUTOMATIC DOWN FEED  
AND SLIDING VICE

TRIFÁSICA CON  
BAJADA AUTOMÁTICA  
Y VICIO DESLIZANTE



**N310DA DG**

SLIDING VICE  
MORDAZA DESLIZANTE

$\square$  320  $\varnothing$  255

Three-phase motor with  
automatic down feed.

Motor trifásica  
con bajada automática.

PAG. 4

THREE-PHASE WITH  
AUTOMATIC DOWN FEED

TRIFÁSICA CON  
BAJADA AUTOMÁTICA



**N276DA XL**

$\square$  265  $\varnothing$  255

Three-phase motor with  
automatic down feed.

Motor trifásica  
con bajada automática.

PAG. 6



VIDEO

THREE-PHASE  
TRIFÁSICA

**N266 XL**

$\square$  265  $\varnothing$  225

Three-phase motor.  
Motor trifásica.

PAG. 8



SINGLE-PHASE WITH  
AUTOMATIC DOWN FEED

MONOFÁSICA CON  
BAJADA AUTOMÁTICA

SINGLE-PHASE  
MONOFÁSICA

2500 LINE / LÍNEA 2500



**N257DA DG**  
SLIDING VICE  
MORDAZA DESLIZANTE

$\square$  253  $\varnothing$  225

Three-phase motor with automatic down feed.  
Motor trifásica con bajada automática.

PAG. 9

MAGNETIKO

NEW



MAGNETIC CHIP COLLECTOR  
suitable for all bandsaws  
VARILLA MAGNÉTICA  
para todas las sierras de cinta.



**N251DA XL**

$\square$  250  $\varnothing$  225

Three-phase motor with automatic down feed.  
Motor trifásica con bajada automática.

PAG. 10

2200 LINE / LÍNEA 2200

H19-1750 LINE / LÍNEA H19-1750



**N250DA XL**

$\square$  250  $\varnothing$  225

Single-phase motor with automatic down feed.  
Motor monofásica con bajada automática.

PAG. 11



**2200DA XL**

$\square$  200  $\varnothing$  175

Single-phase motor with automatic down feed.  
Motor monofásica con bajada automática.

PAG. 12



**ABS 1750 XL**

$\square$  160  $\varnothing$  155

Universal motor.  
Motor universal.  
AUTOMATIC BLADE SYSTEM

PAG. 14



**2200 XL**

$\square$  200  $\varnothing$  175

Universal motor.  
Motor universal.

PAG. 13



**1750 XL**

$\square$  160  $\varnothing$  155

Universal motor.  
Motor universal.

PAG. 15

# N310<sub>DA</sub> DG

AUTOMATIC DOWN FEED  
BAJADA AUTOMÁTICA

ART.	CODE / CÓDIGO
N310 DA DG	8.48.90.26



**SLIDING VICE**  
**0°/60° LEFT**  
**0°/45° RIGHT**

**MORDAZA DESLIZANTE**  
**0°/60° IZQUIERDA**  
**0°/45° DERECHA**

MAX 320 mm

**femim**

**TECHNICAL FEATURES**

- Powerful two speed three-phase motor with oil lubricated gear box
- Arm, vice and swivel group made in cast iron
- Side sliding vice and cut up to 45° right and up to 60° left
- Arm down feed system with hydraulic cylinder and adjustable flow
- Blade tensioning level pressure gauge
- Sliding blade guide with double ball bearings
- Electric/hydraulic front integrated panel
- Motor thermic protection and end-cut switch
- Blade cleaning brush

**STANDARD EQUIPMENT**

- Column in assembly kit
- Quick locking system vice
- End-cut automatic switch
- Alu frame lubrication pump
- Bar-stop rod for mass-produced cuts
- Workpiece roller support

**CARACTERÍSTICAS TÉCNICAS**

- Potente motor trifásico a dos velocidad con motoriductor lubricado
- Brazo, mordaza y base rotatoria en hierro fundido
- Mordaza deslizante lateral y corte hasta 45° derecha y 60° izquierda
- Sistema de bajada brazo con cilindro hidraulico y regulador de flujo
- Manometro que indica la tension de la hoja
- Guia-hoja deslizante en acero con doble cojinetes
- Panel de control electrico / hidraulico delantero integrado
- Proteccion térmica del motor y interruptor de fin del corte
- Cepillo limpio hoja

**EQUIPAMIENTO DE SERIE**

- Base en kit de montaje
- Mordaza con sistema de bloqueo rápido
- Interruptor de parada automática fin del corte
- Bomba de lubricación con cuerpo en aluminio
- Varilla regulable para cortar en serie
- Rodillo de soporte de la pieza



- Side sliding vice and cut up to 45° right and up to 60° left.
- Mordaza deslizante lateral y corte hasta 45° derecha y 60° izquierda.





- Large knob for an easy blade tensioning and pressure gauge indicating blade tensioning level.
- Perilla grande para una tensión de la hoja fácil y manómetro que indica tensión de la hoja.



- Electric/hydraulic front integrated panel for a practical and easy use.
- Panel de control electrico/hidraulico delantero para un uso practito y fácil.

**CUTTING CAPACITY / CAPACIDAD DE CORTE**

			
0°	320x200 mm	255 mm	195 mm
45° left/izquierda	210x80 mm	205 mm	195 mm
60° left/izquierda	120x135 mm	125 mm	125 mm
45° right/derecha	170x190 mm	205 mm	175 mm



1,0/1,5 



2750x27x0.9



6/10\*



35/70



110

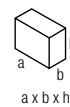

1720x700x1540



344

\*Standard bimetal cobalt blade / De serie hoja bimetálica al cobalto •  400 Volt - Hz 50 three-phase motor / Motor trifásico 400 Volt - Hz 50

# N276DA XL

AUTOMATIC DOWN FEED  
BAJADA AUTOMÁTICA

ART.	CODE / CÓDIGO
N276DA XL	8.48.80.71

**PATENTED**



VIDEO

**femu**



**TECHNICAL FEATURES**

- Blade height 27 mm
- Hydraulic control system for automatic down feed
- Automatic or manual function
- Adjustable left cutting angle from 0° to 60° equipped with quick stop device at 45° and 60° positions
- Blade tensioner with indicator lamp and safety microswitch for proper blade integrity and tensioning

**STANDARD EQUIPMENT**

- Adjustable bar stop-rod for mass-produced cuts (L=600 mm)
- Steel column with built-in tool-holder
- Column in assembly kit

**CARACTERÍSTICAS TÉCNICAS**

- Altura hoja 27 mm
- Sistema hidráulico de control de bajada automática
- Funcionamiento automático o manual
- Ángulo de corte regulable de 0° a 60° izquierda, con dispositivo de bloqueo rápido en las posiciones 45° y 60°
- Tensor de hoja con indicador luminoso y microinterruptor de seguridad para garantizar tensado de la hoja correcto

**EQUIPAMIENTO DE SERIE**

- Varilla de sujeción del material regulable para realizar cortes en serie (L=600 mm)
- Base de acero, con espacio porta-objetos integrado
- Base in kit de montaje



**GREAT CUTTING CAPACITY Ø 255 mm!!!**  
**GRAN CAPACIDAD DE CORTE Ø 255 mm!!!**



- Cast iron arm for a great strength (total weight 305 kg).
- Brazo de hierro fundido de gran robustez (peso total 305 kg).

**CUTTING CAPACITY / CAPACIDAD DE CORTE**

0°	265x200 mm	255 mm	200x200 mm
45°	200x160 mm	175 mm	170x170 mm
60°	115x100 mm	110 mm	100x100 mm



- Hydraulic control system for automatic down feed.
- Sistema hidráulico de control de bajada automática.



1,0/1,3



2565x27x0,9



8/12\*



35/70



60

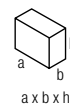

1410x870x1650



311

\*Standard bimetal cobalt blade / De serie hoja bimetálica al cobalto • 400 Volt - Hz 50 three-phase motor / Motor trifásico 400 Volt - Hz 50

# N266 XL

ART.	CODE / CÓDIGO
N266 XL	8.48.80.27

**PATENTED**

### TECHNICAL FEATURES

- Blade height 27 mm
- Cast iron arm for a great strenght
- Vise with quick clamping device and non-skid jaws
- Blade tensioner with indicator lamp and safety microswitch for proper blade integrity
- Adjustable left cutting angle from 0° to 60° equipped with quick stop device at 45° and 60° positions
- Cutting angle front indicator

### STANDARD EQUIPMENT

- Adjustable bar stop-rod for mass-produced cuts (L=600 mm)
- Stainless steel column with built-in tool-holder
- Column in assembly kit

### CARACTERÍSTICAS TÉCNICAS

- Altura hoja 27 mm
- Brazo en hierro fundido de gran robustez
- Mordaza con bloqueo rápido y bocas antideslizantes
- Tensor de hoja con indicador luminoso y microinterruptor de seguridad para garantizar tensado de la hoja correcto
- Ángulo de corte regulable de 0° a 60°, con dispositivo de bloqueo rápido en las posiciones 45° y 60°
- Indicador frontal del ángulo de corte

### EQUIPAMIENTO DE SERIE



- Varilla de sujeción del material regulable para realizar cortes en serie (L=600 mm)
- Base de acero, con espacio porta-objetos integrado
- Base in kit de montaje



MAX 225 mm

**THREE-PHASE TRIFÁSICA**

### CUTTING CAPACITY / CAPACIDAD DE CORTE

			
0°	265x200 mm	225 mm	200x200 mm
45°	200x160 mm	175 mm	170x170 mm
60°	115x100 mm	110 mm	100x100 mm



- Powerful three phase 2 speeds induction motor
- Potente motor de inducción trifásico à 2 velocidades



- Vise with quick clamping device and non-skid jaws
- Mordaza con bloqueo rápido y bocas antideslizantes (peso total 305 kg)



KILOWATT

1,0/1,3 



2565x27x0,9



8/12\*



35/70



WATT

60

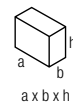

a x b x h

1410x870x1650



Kg

311

\*Standard bimetal cobalt blade / De serie hoja bimetalica al cobalto •  400 Volt - Hz 50 three-phase motor / Motor trifásico 400 Volt - Hz 50

# N257DA DG

**AUTOMATIC DOWN FEED**  
BAJADA AUTOMÁTICA

ART.	CODE / CÓDIGO
N257DA DG	8.48.80.56

**SLIDING VICE**  
0° / 60° LEFT  
0° / 45° RIGHT

**MORDAZA DESLIZANTE**  
0° / 60° IZQUIERDA  
0° / 45° DERECHA

## TECHNICAL FEATURES

- Powerful three phase 2 speeds induction motor, oil lubricated motor gearbox
- Arm, vice and swivel group in cast iron
- Steel sliding blade guide with bearings
- Vice with quick clamping device
- Lubrication pump with aluminium body
- Large knob for an easy blade tensioning
- Pressure gauge indicating blade tension level (600-1000 kg/cm<sup>2</sup>)

## STANDARD EQUIPMENT

- Column in assembly kit
- Tank for lubricating oil
- Lubricating pump
- Bar stop-rod for mass-produced cuts
- Branches for adjustments, blade replacement and blade protection disassembly
- Blade cleaning brush
- Hydraulic cylinder with flow regulation

## CARACTERÍSTICAS TÉCNICAS

- Potente motor de inducción trifásico a 2 velocidades con motorreductor lubricado
- Brazo, mordaza y base rotatoria en hierro fundido
- Guía-hoja deslizante en acero con cojinetes
- Mordaza con sistema de bloqueo rápido
- Bomba de lubricación con cuerpo en aluminio
- Perilla grande para una tensión de la hoja fácil
- Manómetro que indica tensión de la hoja (600-1000 kg / cm<sup>2</sup>)

## EQUIPAMIENTO DE SERIE

- Base en kit de montaje
- Tanque de recogida por aceite lubricante
- Bomba de lubricación
- Varilla de sujeción para realizar cortes en serie
- Llaves para remplazar la hoja y para el desmontaje de la protección de la hoja
- Cepillo para limpiar la hoja
- Cilindro hidráulico con regulador de flujo



**THREE-PHASE**  
TRIFÁSICA

## CUTTING CAPACITY / CAPACIDAD DE CORTE

0°	245xH148- 253xH70	225 mm	180
45° left/izquierda	90xH180	140 mm	120
60° left/izquierda	85xH115	90 mm	90
45° right/derecha	132xH180	148 mm	140



- Hydraulic cylinder with flow regulation
- Cilindro hidráulico con regulador de flujo

 KILOWATT	 mm	 Z1"	 M/min	 WATT	 a x b x h mm	 Kg
0,75/1,1	2480x27x0,9	6/1 0*	45/90	100	1385x580x890	235

\*Standard bimetal cobalt blade / De serie hoja bimetálica al cobalto • 400 Volt - Hz 50 three-phase motor / Motor trifásico 400 Volt - Hz 50

# N251DA XL

**AUTOMATIC DOWN FEED**  
**BAJADA AUTOMÁTICA**

ART.	CODE / CÓDIGO
N251DA XL	8.48.80.50

## TECHNICAL FEATURES

- Powerful three phase 2 speeds induction motor, oil lubricated motor gearbox
- Arm, vice and swivel group in cast iron
- Steel sliding blade guide with bearings
- Vice with quick clamping device
- Frontal swivel release lever integrated in the base
- Lubrication pump with aluminium body
- Large knob for an easy blade tensioning
- Pressure gauge indicating blade tension level (600-1000 kg/cm<sup>2</sup>)

## STANDARD EQUIPMENT

- Column in assembly kit
- Tank for lubricating oil
- Lubricating pump
- Bar stop-rod for mass-produced cuts
- Branches for adjustments, blade replacement and blade protection disassembly
- Blade cleaning brush
- Hydraulic cylinder with flow regulation

## CARACTERÍSTICAS TÉCNICAS

- Base en kit de montaje
- Tanque de recogida por aceite lubricante
- Bomba de lubricación
- Varilla de sujeción para realizar cortes en serie
- Llaves para remplazar la hoja y para el desmontaje de la protección de la hoja
- Cepillo para limpiar la hoja
- Cilindro hidráulico con regulador de flujo

## EQUIPEMENTS DE SÉRIE

- Potente motor de inducción trifásico à 2 velocidades con motorreductor lubricado
- Brazo, mordaza y base rotatoria en hierro fundido
- Guia-hoja deslizante en acero con cojinetes
- Mordaza con sistema de bloqueo rápido
- Palanca frontal de desbloqueo de la base giratoria integrada en la base
- Bomba de lubricación con cuerpo en aluminio
- Perilla grande para una tensión de la hoja fácil
- Manómetro que indica tensión de la hoja (600-1000 kg/cm<sup>2</sup>)



**THREE-PHASE**  
**TRIFÁSICA**

## CUTTING CAPACITY / CAPACIDAD DE CORTE

0°	L 240 x H 160 mm L 250 x H 110 mm	225 mm	185x185 mm
45°	L 135 x H 185mm L 145 x H 150 mm	150 mm	145x145 mm
60°	L 63 x H 107 L 69 x H 90	70 mm	70x70 mm



- Powerful three phase 2 speeds induction motor
- Potente motor de inducción trifásico à 2 velocidades



- Hydraulic cylinder with flow regulation
- Cilindro hidráulico con regulador de flujo



0,75/1,1



2480x27x0,9



6/10\*



45/90



100

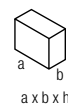

1385x580x890



200

\*Standard bimetal cobalt blade / De serie hoja bimetálica al cobalto • 400 Volt - Hz 50 three-phase motor / Motor trifásico 400 Volt - Hz 50

# N250DA XL

**AUTOMATIC DOWN FEED**  
BAJADA AUTOMÁTICA

ART.	CODE / CÓDIGO
N250DA XL	8.48.80.52

### TECHNICAL FEATURES

- Powerful single phase induction motor, oil lubricated motor gearbox
- Arm, vice and swivel group in cast iron
- Arm down feed system through hydraulic cylinder with flow regulation
- Steel sliding blade guide with bearings
- Vice with quick clamping device
- Frontal swivel release lever integrated in the base
- Lubrication pump with aluminium body
- Pressure gauge indicating blade tension level (600-1000 kg/cm<sup>2</sup>)

### STANDARD EQUIPMENT

- Column in assembly kit
- Tank for lubricating oil
- Lubricating pump
- Bar stop-rod for mass-produced cuts
- Bunches for adjustments, blade replacement and blade protection disassembly
- Blade cleaning brush
- Hydraulic cylinder with flow regulation

### CARACTERÍSTICAS TÉCNICAS

- Potente motor de inducción monofásico con motorreductor lubricado
- Brazo, mordaza y base en hierro fundido
- Sistema de bajada del brazo a través de cilindro hidráulico con regulador de flujo
- Guía-hoja deslizante en acero con cojinetes
- Mordaza con sistema de bloqueo rápido
- Palanca frontal de desbloqueo de la base giratoria integrada en la base
- Bomba de lubricación con cuerpo en aluminio
- Manómetro que indica tensión de la hoja (600-1000 kg/cm<sup>2</sup>)



### EQUIPEMENTS DE SÉRIE

- Base en kit de montaje
- Tanque de recogida por aceite lubricante
- Bomba de lubricación
- Varilla de sujeción para realizar cortes en serie
- Llaves para remplazar la hoja y para el desmontaje de la protección de la hoja
- Cepillo para limpiar la hoja
- Cilindro hidráulico con regulador de flujo



**SINGLE PHASE**  
MONOFÁSICA

### CUTTING CAPACITY / CAPACIDAD DE CORTE

			
0°	L 240 x H 160 mm L 250 x H 110 mm	225 mm	185x185 mm
45°	L 135 x H 185mm L 145 x H 150 mm	150 mm	145x145 mm
60°	L 63 x H 107 L 69 x H 90	70 mm	70x70 mm



- Rear blade guide with blade cleaning brush
- Guía hoja posterior con cepillo para limpiar la hoja



- Large knob for an easy blade tensioning and pressure gauge indicating blade tensioning level
- Perilla grande para una tensión de la hoja fácil y manómetro que indica tensión de la hoja



1100 



2480x27x0,9



6/10\*



72



100

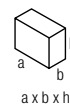

1385x580x890



200

\*Standard bimetal cobalt blade / De serie hoja bimetálica al cobalto •  230 Volt - Hz 50 single-phase motor / Motor monofásico 230 Volt - Hz 50

# 2200 DA XL

AUTOMATIC DOWN FEED  
BAJADA AUTOMÁTICA

ART.	CODE / CÓDIGO
2200DA XL	8.48.70.24

## TECHNICAL FEATURES

- Hydraulic control system of arm down feed speed
- End-cut stop by micro switch system
- Blade tensioning device with light indicator and safety micro-switch to check the proper blade tension
- Powerful 2000 W universal single-phase motor equipped with digital electronic speed regulator "Constant Speed" and amperometric limiting device

## STANDARD EQUIPMENT

- Integrated and protected lubricating system
- Filter-circuit for electromagnetic interference damping according to rules in force
- Column included in assembly kit

## CARACTERÍSTICAS TÉCNICAS

- Sistema de control hidráulico de la velocidad de bajada
- Micro interruptor de fin carrera de corte
- Tensado de la hoja con indicador luminoso y microinterruptor de seguridad para controlar la integridad de la hoja
- Potente motor monofásico universal (2000 W) con regulación electrónica digital de velocidad "Constant Speed" con limitador amperimétrico y protección térmica



## EQUIPAMIENTO DE SERIE

- Instalación de lubricación/refrigeración integrada y protegida
- Circuito-filtro para la eliminación de interferencias electromagnéticas conforme con las normativas vigentes
- Base en kit de montaje



SINGLE PHASE  
MONOFÁSICA

## CUTTING CAPACITY / CAPACIDAD DE CORTE

			
0°	200x75 mm 190x135 mm	175 mm	175x175 mm
45°	150x110 mm	110 mm	110x110 mm
60°	100x70 mm	75 mm	75x75 mm



- Control panel in ergonomic position for starting and adjusting the cutting operations.
- Panel de control en posición ergonómica para iniciar y ajustar las operaciones de corte.



- Closed circuit hydraulic system for arm descent control.
- Sistema hidráulico de circuito cerrado para control de la bajada del brazo.



2000 



2140x19x0,9



6/10\*



35 ÷ 80

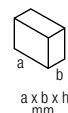

780x1240x1080



143

\*Standard bimetal cobalt blade / De serie hoja bimetálica al cobalto •  230 Volt - Hz 50 single-phase motor / Motor monofásico 230 Volt - Hz 50

# 2200 XL

ART.	CODE / CÓDIGO
2200 XL	8.48.70.22

## TECHNICAL FEATURES

- Blade tensioning device with light indicator and safety micro-switch to check the proper blade tension
- Powerful 2000 W universal single-phase motor equipped with digital electronic speed regulator "Constant Speed" and amperometric limiting device
- Cast iron quick locking vice with quick sliding system
- Front sliding saw blade guide

## STANDARD EQUIPMENT

- Integrated and protected lubricating system
- Filter-circuit for electromagnetic interference damping according to rules in force
- Column included in assembly kit

## CARACTERÍSTICAS TÉCNICAS



- Tensado de la hoja con indicador luminoso y microinterruptor de seguridad para controlar la integridad de la hoja
- Potente motor monofásico universal (2000 W) con regulación electrónica digital de velocidad "Constant Speed" con limitador amperimétrico y protección térmica
- Mordaza de hierro fundido de bloqueo rápido, provista de sistema de deslizamiento veloz
- Guía-hoja deslizable anterior

## EQUIPAMIENTO DE SERIE

- Instalación de lubricación/refrigeración integrada y protegida
- Circuito-filtro para la eliminación de interferencias electromagnéticas conforme con las normativas vigentes
- Base en kit de montaje



## CUTTING CAPACITY / CAPACIDAD DE CORTE

			
0°	200x75 mm 190x135 mm	175 mm	175x175 mm
45°	150x110 mm	110 mm	110x110 mm
60°	100x70 mm	75 mm	75x75 mm



- Cut with lubrication system max 200 mm
- Corte con lubricación max 200 mm



- Cast iron quick locking vice with quick sliding system.
- Mordaza de hierro fundido de bloqueo rápido, provista de sistema de deslizamiento veloz.



2000 



2140x19x0,9



6/10\*



35 ÷ 80

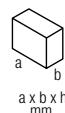

780x1240x1080



140

\*Standard bimetal cobalt blade / De serie hoja bimetálica al cobalto •  230 Volt - Hz 50 single-phase motor / Motor monofásico 230 Volt - Hz 50

# ABS 1750 XL



ART.	CODE / CÓDIGO
ABS 1750 XL	8.48.60.91

## TECHNICAL FEATURES

- Push-Click System with mechanical selector and automatic cut-off switches
- Integrated lubricating system, easy to adjust for cutting pieces of different sizes
- Sliding rolls for supporting in- and out-going workpieces
- Safety emergency button to stop cutting
- Blade tensioning device with clutch to achieve the proper blade tension (PATENTED)
- Energy saving 100% motor efficiency is granted by the exclusive ABS System

## STANDARD EQUIPMENT

- Column in assembly kit
- Removable Tank for lubricating oil
- Lubricating pump
- Bar stop-rod for mass-produced cuts
- Sliding rolls for supporting both in- and out-going workpieces

## CARACTERÍSTICAS TÉCNICAS

- Push-click: 4 velocidades de corte, con selector mecánico
- Sistema integrado de lubricación, fácil a orientar para cortar piezas de diferentes tamaños
- Rodillas deslizantes por el apoyo de las piezas en entrada y salida
- Botón de seguridad para detener el corte
- Tensor de la hoja con embrague para la correcta regulación del tensado (PATENTADO)
- El exclusivo sistema ABS asegura el 100% del rendimiento del motor

## EQUIPEMENTS DE SÉRIE

- Base en kit de montaje
- Bañera extraíble por aceite lubricante
- Bomba de lubricación
- Varilla de sujeción para realizar cortes en serie
- Rodillos deslizantes por el apoyo de las piezas en entrada y salida



**BLADE HEIGHT**  
19 mm!  
**LAMA ALTURA**  
19 mm!

## CUTTING CAPACITY / CAPACIDAD DE CORTE

0°	160x140 mm	155 mm	150x150 mm
45°	100x120 mm	110 mm	100x100 mm



- Blade height 19mm for a more heavy duty work
- Lama altura 19mm para un trabajo más intenso y continuo



- Push-Click system: 4 downfeed speeds with mechanical selector
- Push-Click: 4 velocidad de corte con selector mecánico



2000



1735x19x0,9



8/12\*



35 ÷ 80

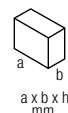

780x1240x1080



75

\*Standard bimetal cobalt blade / De serie hoja bimetálica al cobalto • 230 Volt - Hz 50 single-phase motor / Motor monofásico 230 Volt - Hz 50



# 1750 XL

ART.	CODE / CÓDIGO
1750 XL	8.48.60.90

### TECHNICAL FEATURES

- Blade height 19 mm for a more heavy duty work
- Integrated lubricating system, easy to adjust for cutting pieces of different sizes
- Sliding rolls for supporting in- and out-going workpieces
- Integrated quick sliding vice
- Blade tensioning device with clutch to achieve the proper blade tension (PATENTED)
- Double sliding saw blade guide

### STANDARD EQUIPMENT

- Column in assembly kit
- Removable Tank for lubricating oil
- Lubricating pump
- Bar stop-rod for mass-produced cuts
- Sliding rolls for supporting both in- and out-going workpieces

### CARACTERÍSTICAS TÉCNICAS

- Lama altura 19 mm para un trabajo más intenso y continuo
- Sistema integrado de lubricación, fácil a orientar para cortar piezas de diferentes tamaños
- Rodillos deslizantes por el apoyo de las piezas en entrada y salida
- Base con mordaza integrada y sistema de deslizamiento veloz
- Tensor de la hoja con embrague para la correcta regulación del tensado (PATENTADO)

### EQUIPEMENTS DE SÉRIE

- Base en kit de montaje
- Bañera extraíble por aceite lubricante
- Bomba de lubricación
- Varilla de sujeción para realizar cortes en serie
- Rodillos deslizantes por el apoyo de las piezas en entrada y salida



**BLADE HEIGHT 19 mm!**  
LAMA ALTURA 19 mm!

### CUTTING CAPACITY / CAPACIDAD DE CORTE

0°	160x140 mm	155 mm	150x150 mm
45°	100x120 mm	110 mm	100x100 mm



- Blade height 19 mm for a more heavy duty work.
- Lama altura 19 mm para un trabajo más intenso y continuo.



- Powerful motor (2000 watt) to cut any kind of material.
- Potente motor (2000 W) para cortar cualquier material.



2000



1735x19x0,9



8/12\*



35 ÷ 80



LT min 8,5

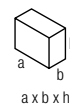

780x1240x1080



75

\*Standard bimetal cobalt blade / De serie hoja bimetálica al cobalto • 230 Volt - Hz 50 single-phase motor / Motor monofásico 230 Volt - Hz 50

**ROLLER STANDS / SOPORTE RODILLOS MODULARES**

ART.	CODE CÓDIGO	SIZE AxBxH (mm) DIMENSIONES AxBxH (mm)	ROLLER CAPACITY CAPACIDAD DEL RODILLO	APPLICATION APLICACIÓN	FOR ART. PARA ART.
326	7.13.37.03	1000x300x880÷970	200 kg	Bars loading/unloading Carga/descarga barras	N310DA DG - N257 DADG - N276DA XL N250DA XL - N251DA XL - N266DA XL
327	7.13.37.04	1000x300x880÷970	200 kg	Supplemental module Módulo adicional	- N266XL - N265XL - N216XL - 2200XL - 2200DA XL

**TECHNICAL FEATURES**

- Steel rollers Ø 50 mm fitted with bearings
- Liquid collection tank made of sturdy steel sheet
- Pipe steel structure. Adjustable support feet
- Possibility to fit 8 vertical antifall rollers

**CARACTERÍSTICAS TÉCNICAS**

- Rodillos de acero Ø 50 mm montados sobre cojinetes
- Recipiente de recogida del líquido de robusta chapa de acero
- Estructura tubular de acero. Pies de apoyo de altura regulable
- Adaptación para 8 rodillos verticales anticaída

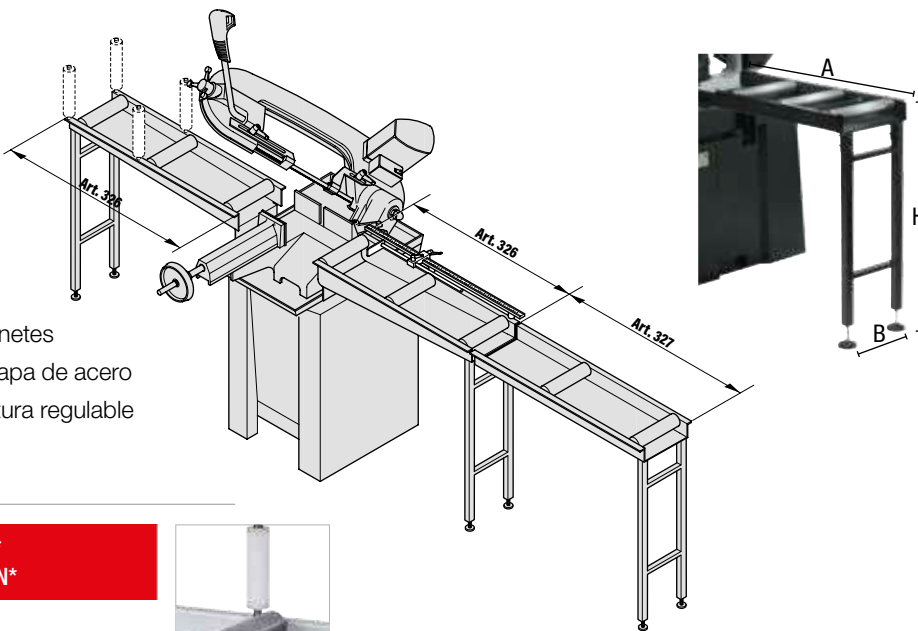

**VERTICAL ANTI-FALL TEFLON ROLLER\*  
RODILLO VERTICAL REVESTIDO DE TEFLÓN\***

CODE / CÓDIGO	SIZE (mm) / DIMENSIONES (mm)
7.21.42.11	Ø 40x150



**MILLIMETRIC BAR STOP RODS\* / VARILLAS DE SUJECCIÓN DE LA BARRA MILLIMETRADA\***

CODE / CÓDIGO	FOR ART. / PARA ART.	LENGHT / LARGO
7.13.05.76	326	1000 mm
7.13.05.77	327	1000 mm

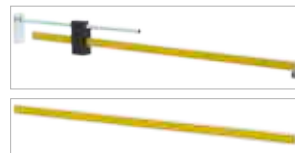

\*On request / Bajo pedido



**TECHNICAL FEATURES**

- Zinc-plated steel roller Ø 57 mm
- Sturdy steel structure
- Base equipped with leveling feet
- Support height adjustment
- Maximum charge: 30 kg

**CARACTERÍSTICAS TÉCNICAS**

- Rodillo de acero galvanizado ø 57 mm
- Robusta estructura de acero, hierro fundido
- Base provista de pies de nivelación
- Regulación de la altura de apoyo
- Max posibilidad de carga: 30 kg

**SINGLE-ROLLER SUPPORT / SOPORTE MONO-RODILLO**

ART.	CODE CÓDIGO	SIZE AxBxH (mm) DIMENSIONES AxBxH (mm)	WEIGHT PESO
301	7.13.37.16	520x400x680÷1140	6,5 kg

**NEW**

















**TECHNICAL FEATURES**

- Magnetic chip collector with ergonomic handle
- Stainless and lightweight shaft
- Ideal to reach hard areas
- To collect metal chips, nails and small metal components from chip-releasing machinery
- By extracting the central bar you can easily release the collected metal parts

**CARACTERÍSTICAS TÉCNICAS**

- Varilla magnética con mango ergonómico
- Eje inoxidable y liviano
- Ideal para zonas de difícil acceso
- Para recoger virutas de metal, clavos y pequeños componentes metálicos de la maquinaria liberadora de virutas.
- Extrayendo la barra central podrás liberar fácilmente las piezas metálicas recogidas

**CENTRIFUGAL PUMPS / ELECTROBOMBAS CENTRÍFUGAS**

ART.	CODE CÓDIGO	 WATT	 mm	TYPE OF PUMP USED TIPO DE BOMBA APLICADA
120	8.38.20.21	60 	60	-
121	8.38.21.21	60 	85	-
122	8.38.22.21	60 	120	-
123	8.38.23.21	60 	150	-
220	8.38.16.31	180 	200	-
221	8.38.17.31	180 	260	-
222	8.38.18.31	250 	200	-
223	8.38.19.31	250 	260	-
226	8.38.10.31	120 	-	art. 228
227	8.38.07.31	120 	90	-
228	8.38.08.31	120 	120	-
229	8.38.09.31	120 	200	-

 230 Volt - Hz 50 single-phase motor / Motor monofásico 230 Volt - Hz 50

 400 Volt - Hz 50 three-phase motor / Motor trifásico 400 Volt - Hz 50

The continuous service self-priming electric pumps are suitable for continuous coolant flow and assure absolute operating safety even at high temperatures.

Las electrobombas con autocebado para servicio continuo, son aptas para la circulación continua de líquidos refrigerantes, y garantizan una absoluta seguridad de funcionamiento con elevadas temperaturas.



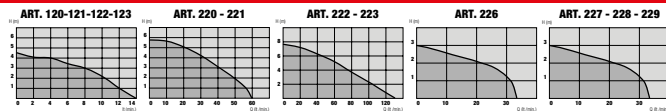

**LOADING DIAGRAMS / DIAGRAMAS DE CARGA**

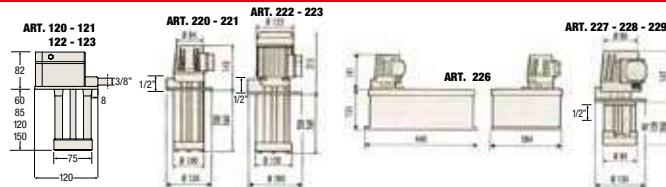

**ELECTRIC PUMP DIMENSIONS / DIMENSIONES DE LAS ELECTROBOMBAS**



**HANGING FLEXIBLE SYSTEM / EQUIPO FLEXIBLE PÉNSIL**

ART.	CODE CÓDIGO	 WATT	 RPM	FLEXIBLE SHAFT ÁRBOL FLEXIBLE	BUNDLE PIEZA DE MANO	CHUCK MANDRIL	 Kg
623	8.31.07.21	350 	21000	∅ 6x14x1200	∅ 24	∅ 6	3,2

 230 Volt - Hz 50 single-phase motor / Motor monofásico 230 Volt - Hz 50

**TECHNICAL FEATURES**

- Handy and versatile
- Electronic device for speed adjustment
- Double safety insulation

**STANDARD EQUIPMENT**

- Flexible shaft
- Chuck for ∅ 6mm tools
- Electronic pedal rheostat

**ACCESSORIES**

- Chuck ∅ 2,3 - 3 - 4 mm
- Support rod

**CARACTERÍSTICAS TÉCNICAS**

- Sumamente manejable y versátil
- Velocidad regulable electrónicamente
- Doble aislamiento de seguridad

**EQUIPAMIENTO DE SERIE**

- Arbol flexible
- Mandril para herramienta ∅ 6 mm
- Reòstato electrònico a pedal

**ACCESORIOS**

- Madril ∅ 2,3 - 3 - 4 mm
- Varilla de soporte



CODE  
CÓDIGO

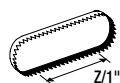

PACK  
CAJA

**TECHNICAL FEATURES**

- Bimetal cobalt blades M42 for high cutting performance
- Suitable for dry cutting, too
- High resistance and productivity both for solid materials and for profiles
- Available in standard packs of 1 or 5 pieces

**CARACTERÍSTICAS TÉCNICAS**

- Hojas bimetálicas al cobalto M42 para elevadas prestaciones de corte
- Ideales también para cortes en seco
- Gran resistencia y productividad tanto en materiales macizos como en perfilados
- Disponibles en paquetes estándar de 1 ó 5 piezas

**ART. N310 DA DG**

**2700**

<b>3.28.00.56</b>	2750x27x0,9	6/10*	1 pc
<b>3.28.00.60</b>	2750x27x0,9	6/10*	5 pc
<b>3.28.00.55</b>	2750x27x0,9	4/6	1 pc
<b>3.28.00.59</b>	2750x27x0,9	4/6	5 pc
<b>3.28.00.54</b>	2750x27x0,9	8/12	1 pc
<b>3.28.00.58</b>	2750x27x0,9	8/12	5 pc
<b>3.28.00.57</b>	2750x27x0,9	10/14	1 pc
<b>3.28.00.61</b>	2750x27x0,9	10/14	5 pc

**ART. N276DAXL-N266DAXL-N266XL-N265XL**

**2600**

<b>3.28.00.28</b>	2565x27x0,9	8/12*	1 pc.
<b>3.28.00.32</b>	2565x27x0,9	8/12*	5 pc.
<b>3.28.00.26</b>	2565x27x0,9	4/6	1 pc.
<b>3.28.00.30</b>	2565x27x0,9	4/6	5 pc.
<b>3.28.00.27</b>	2565x27x0,9	5/8	1 pc.
<b>3.28.00.31</b>	2565x27x0,9	5/8	5 pc.
<b>3.28.00.29</b>	2565x27x0,9	10/14	1 pc.
<b>3.28.00.33</b>	2565x27x0,9	10/14	5 pc.

**ART. N257DADG-N251DAXL-N250DAXL**

**2500**

<b>3.28.00.42</b>	2480x27x0,9	6/10*	1 pc.
<b>3.28.00.44</b>	2480x27x0,9	6/10*	5 pc.
<b>3.28.00.39</b>	2480x27x0,9	4/6	1 pc.
<b>3.28.00.41</b>	2480x27x0,9	4/6	5 pc.
<b>3.28.00.38</b>	2480x27x0,9	8/12	1 pc.
<b>3.28.00.40</b>	2480x27x0,9	8/12	5 pc.
<b>3.28.00.43</b>	2480x27x0,9	10/14	1 pc.
<b>3.28.00.45</b>	2480x27x0,9	10/14	5 pc.

**ART. 787DAXL\*\*-787XL\*\*-2200DAXL\*-2200XL\*-N216XL\***

**2200**

<b>3.27.99.36</b>	2140x19x0,9	6/10*	1 pc.
<b>3.27.99.39</b>	2140x19x0,9	6/10*	5 pc.
<b>3.28.00.24</b>	2140x19x0,9	8/12**	1 pc.
<b>3.28.00.25</b>	2140x19x0,9	8/12**	5 pc.
<b>3.27.99.38</b>	2140x19x0,9	4/6	1 pc.
<b>3.27.99.41</b>	2140x19x0,9	4/6	5 pc.
<b>3.27.99.37</b>	2140x19x0,9	14	1 pc.
<b>3.27.99.40</b>	2140x19x0,9	14	5 pc.

**ART. ABS 1750XL-1750XL**

**H19mm - 1750**

<b>3.28.00.47</b>	1735x19x0,9	8/12*	1 pc.
<b>3.28.00.51</b>	1735x19x0,9	8/12*	5 pc.
<b>3.28.00.48</b>	1735x19x0,9	4/6	1 pc.
<b>3.28.00.52</b>	1735x19x0,9	4/6	5 pc.
<b>3.28.00.46</b>	1735x19x0,9	6/10	1 pc.
<b>3.28.00.50</b>	1735x19x0,9	6/10	5 pc.
<b>3.28.00.49</b>	1735x19x0,9	14	1 pc.
<b>3.28.00.53</b>	1735x19x0,9	14	5 pc.

\* Standard fitting on bandsaws / En dotación estándar en las SIERRA

# CHOOSE YOUR BLADE! ¡ HELIGE TU HOYA



BI-METAL BAND SAW BLADES IN M42 HSS that combine excellent thermal resistance with high cutting speed. The particular structure of the blade allows it to resist bending, tension and pressure stresses.

HOJAS DE SIERRA DE CINTA BIMETÁLICAS EN M42 HSS que combinan una excelente resistencia térmica con una alta velocidad de corte. La estructura particular de la hoja le permite resistir tensiones de flexión, tensión y presión.



## SOLID MATERIALS / MATERIALES SÓLIDOS

BLADE HOJA	ABS 1750XL - 1750XL				2200XL - 2200 DAXL				N250DA XL N251DA XL N257DA DG				N266XL - N276DA XL				N310 DA DG			
	1735x19x0,9mm				2140x19x0,9mm				2480x27x0,9mm				2565x27x0,9mm				2750x27x0,9mm			
TPI (Teeth Per Inch) Dientas para inch	Z14	Z8/12	Z6/10	Z4/6	Z14	Z8/12	Z6/10	Z4/6	Z10/14	Z8/12	Z6/10	Z4/6	Z10/14	Z8/12	Z5/8	Z4/6	Z10/14	Z8/12	Z6/10	Z4/6
<b>Stainless Steel</b> Acero inoxidable	•	•	••	•••	•	•	••	•••	•	••	•••	•••	•	••	•••	•••	•	••	•••	•••
<b>Cast Iron</b> Hierro fundido	•	••	•••	•••	•	••	•••	•••	•	••	•••	•••	•	••	•••	•••	•	••	•••	•••
<b>Iron</b> Hierro	•	•	••••	•••	•	••	••••	•••	•	•••	•••	•••	•	•••	•••	•••	•	•••	•••	•••
<b>Aluminum</b> Aluminio	•	•	••	••••	•	•	••	••••	•	••	••••	••••	•	••	••••	••••	•	••	••••	••••
<b>Plastic</b> Plastico	•	••	••	••••	•	••	••	••••	•	••	••••	••••	•	••	••••	••••	•	••	••••	••••
<b>Brass</b> Latón	•	••	••	••	•	••	••	••	•	••	••	••	•	••	••	••	•	••	••	••
<b>Copper</b> Cobre	•	••	••••	••	•	••	••	••	•	••	••	••	•	••	••	••	•	••	••	••

• Not recommended, •• Acceptable, ••• Good, •••• PRO Level  
• No recomendado, •• Admisible, ••• Bueno, •••• Nivel PRO

Z = Teeth Per Inch.  
Z = Dientas para inch.



## PIPES & PROFILES / TUBERIA Y PERFILES

BLADE HOJA	ABS 1750XL - 1750XL				2200XL - 2200 DAXL				N250DA XL N251DA XL N257DA DG				N266XL - N276DA XL				N310 DA DG			
	1735x19x0,9mm				2140x19x0,9mm				2480x27x0,9mm				2565x27x0,9mm				2750x27x0,9mm			
TPI (Teeth Per Inch) Dientas para inch	Z14	Z8/12	Z6/10	Z4/6	Z14	Z8/12	Z6/10	Z4/6	Z10/14	Z8/12	Z6/10	Z4/6	Z10/14	Z8/12	Z5/8	Z4/6	Z10/14	Z8/12	Z6/10	Z4/6
<b>Stainless Steel</b> Acero inoxidable	••••	•••	•	•	••••	•••	•	•	•••	••	•	•	•••	••	•	•	•••	••	•	•
<b>Cast Iron</b> Hierro fundido	•••	•••	••	•	•••	•••	••	•	••	•••	••	•	••	•••	••	•	••	•••	••	•
<b>Iron</b> Hierro	••••	•••	•	•	••••	•••	•	•	••••	•••	•	•	••••	•••	•	•	••••	•••	•	•
<b>Aluminum</b> Aluminio	•••	••	••	•	•••	••	••	•	••••	•••	••	•	••••	•••	••	•	••••	•••	••	•
<b>Plastic</b> Plastico	•••	••••	•••	•	•••	••••	••	•	••••	••	••	•	••••	••	••	•	••••	••	••	•
<b>Brass</b> Latón	•••	••••	•••	•	•••	••••	•••	•	•••	•••	•••	•	•••	•••	•••	•	•••	•••	•••	•
<b>Copper</b> Cobre	•••	••••	•••	•	•••	••••	•••	•	••••	•••	•••	•	••••	•••	•••	•	••••	•••	•••	•

• Not recommended, •• Acceptable, ••• Good, •••• PRO Level  
• No recomendado, •• Admisible, ••• Bueno, •••• Nivel PRO

Z = Teeth Per Inch.  
Z = Dientas para inch.

1330 LINE / LÍNEA 1330



**ABS**  
Automatic Blade System



**ABS 105**  
Ø 105  
PAG. 24



**NG**  
NEW GENERATION

**DCS**  
DIGITAL CUTTING SYSTEM

DCS NG110  
Ø 110



PAG. 30

**NG105 XL**  
Ø 105



**NEW**



**780XL**  
Ø 105  
PAG. 37



**782XL**  
Ø 105  
PAG. 35



**XL**  
EXTRA LARGE

**783XL**  
Ø 105



**782XL** ⚡ 48 VOLT  
Ø 105



1440 LINE / LÍNEA 1440

1750 LINE / LÍNEA 1750

**ABS NG 120**

∅120

PAG. 23



VIDEO

**ABS NG 160**

∠160

PAG. 22



VIDEO

**MAGNETIKO**

**NEW**



MAGNETIC CHIP COLLECTOR  
suitable for all bandsaws  
VARILLA MAGNÉTICA  
para todas las sierras de cinta.

**NG120XL**

∅120

PAG. 29



VIDEO

**NG160**

∠160

PAG. 28



2200 LINE / LÍNEA 2200

**787 DA XL** ∠213

**allroad**



VIDEO

PAG. 32

**784XL**

∅120

PAG. 34



**785XL**

∠205

PAG. 33



**787 XL** ∠213

**allroad**



# ABS Ng160

**ABS**  
Automatic Blade System

ART.	CODE / CÓDIGO
ABS NG160	8.48.60.80



## TECHNICAL FEATURES

- Push-click: 4 down feed speeds with mechanical selector
- Automatic cut-off switch after finishing cutting operation
- Safety emergency button to stop cutting
- Energy saving 100% motor efficiency is granted by the exclusive ABS system
- Maximum cutting versatility on all metal materials
- More than 10% saving on blade consumption

## STANDARD EQUIPMENT

- Adjustable bar stop-rod for mass-produced cuts (L=500 mm)
- Handles for easy handling
- Filter-circuit for electromagnetic interference damping according to rules in force

## CARACTERÍSTICAS TÉCNICAS

- Push-click 4 velocidades de corte, con selector mecánico
- Interruptor de parada automática al final del corte
- Botón de seguridad para detener el corte
- El exclusivo sistema abs asegura el 100% del rendimiento del motor
- Máxima versatilidad de corte sobre todo tipo de metal
- Más del 10% de ahorro en el consumo de la hoja de sierra

## EQUIPEMENTS DE SÉRIE

- Varilla de sujeción regulable para realizar cortes en serie (L=500 mm)
- Asas para el transporte
- Circuito-filtro para la eliminación de interferencias electromagnéticas conforme con las normativas vigentes



## CUTTING CAPACITY / CAPACIDAD DE CORTE

0°	160x140 mm	150 mm	150x150 mm
45°	105x120 mm	100 mm	100x100 mm

For solid materials we suggest to reduce the maximum cutting diameter  
Para el material macizo se aconseja reducir el diámetro máximo de corte

## FULLY AUTONOMOUS CUTTING CYCLE WITHOUT OPERATOR / CICLO DE CORTE COMPLETAMENTE AUTÓNOMO, SIN PRESENCIA DEL OPERARIO

**ABS**  
Automatic Blade System



2000



1735x13x0,9



14\*



35 ÷ 80

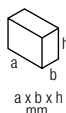

1000x390x570



36

\*Standard bimetal cobalt blade / De serie hoja bimetálica al cobalto • 230 Volt - Hz 50 single-phase motor / Motor monofásico 230 Volt - Hz 50



# ABS NG120



ART.	CODE / CÓDIGO
ABS NG120	8.48.50.80



VIDEO

## TECHNICAL FEATURES

- Push-click: 4 down feed speeds with mechanical selector
- Automatic cut-off switch after finishing cutting operation
- Safety emergency button to stop cutting
- Energy saving 100% motor efficiency is granted by the exclusive ABS system
- Maximum cutting versatility on all metal materials (AL, Acc, Inox)
- More than 10% saving on blade consumption

## STANDARD EQUIPMENT

- Adjustable bar stop-rod for mass-produced cuts (L=500 mm)
- Tools for changing blade
- Filter-circuit for electromagnetic interference damping according to rules in force

## CARACTERÍSTICAS TÉCNICAS

- Push-click 4 velocidades de corte, con selector mecánico
- Interruptor de parada automática al final del corte
- Botón de seguridad para detener el corte
- El exclusivo sistema abs asegura el 100% del rendimiento del motor
- Máxima versatilidad de corte sobre todo tipo de metal (AL, Acc, Inox)
- Más del 10% de ahorro en el consumo de la hoja de sierra

## EQUIPEMENTS DE SÉRIE

- Varilla tope regulable para realizar cortes en serie (L=500 mm)
- Herramienta para el cambio de la hoja
- Circuito-filtro para la eliminación de interferencias electromagnéticas conforme con las normativas vigentes

**PATENTED**



MAX 120 mm

**WITHOUT LUBRICATION  
SIN LUBRICACION**

FASTER / MÁS VELOZ  
**60%**



## CUTTING CAPACITY / CAPACIDAD DE CORTE

0°	120x102 mm	120 mm	112x112 mm
45°	78x78 mm	80 mm	78x78 mm
60°	50x43 mm	50 mm	48x48 mm

## FULLY AUTONOMOUS CUTTING CYCLE WITHOUT OPERATOR / CICLO DE CORTE COMPLETAMENTE AUTÓNOMO, SIN PRESENCIA DEL OPERARIO



1300



1440x13x0,65



14\*



35 ÷ 80

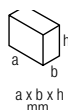

900x400x520



19

\*Standard bimetal cobalt blade / De serie hoja bimetálica al cobalto • 230 Volt - Hz 50 single-phase motor / Motor monofásico 230 Volt - Hz 50



# ABS 105

**ABS**  
Automatic Blade System

ART.	CODE / CÓDIGO
ABS 105	8.48.46.81

**PATENTED**



### TECHNICAL FEATURES

- Push-click: 4 down feed speeds with mechanical selector
- Automatic cut-off switch after finishing cutting operation
- Safety emergency button to stop cutting
- Energy saving 100% motor efficiency is granted by the exclusive ABS system
- Maximum cutting versatility on all metal materials (AL, Acc, Innox)
- More than 10% saving on blade consumption

### STANDARD EQUIPMENT

- Adjustable bar stop-rod for mass-produced cuts (L=500 mm).
- Blade cleaning felt spares kit
- Filter-circuit for electromagnetic interference damping according to rules in force

### CARACTERÍSTICAS TÉCNICAS

- Push-click 4 velocidades de corte, con selector mecánico
- Interruptor de parada automática al final del corte
- Botón de seguridad para detener el corte
- El exclusivo sistema abs asegura el 100% del rendimiento del motor
- Máxima versatilidad de corte sobre todo tipo de metal (AL, Acc, Innox)
- Más del 10% de ahorro en el consumo de la hoja de sierra

### EQUIPEMENTS DE SÉRIE

- Varilla de sujeción de la barra regulable, para realizar cortes en serie (L=500 mm)
- Kit de recambio filtro de limpieza de la hoja
- Circuito-filtro para la eliminación de interferencias electromagnéticas conforme con las normativas vigentes



### CUTTING CAPACITY / CAPACIDAD DE CORTE

0°	100x85 mm	105 mm	95x95 mm
45°	65x60 mm	65 mm	65x65 mm

### FULLY AUTONOMOUS CUTTING CYCLE WITHOUT OPERATOR / CICLO DE CORTE COMPLETAMENTE AUTÓNOMO, SIN PRESENCIA DEL OPERARIO

**ABS**  
Automatic Blade System



950	1335x13x0,65	8/12*	60/80	730x390x500	17

\*Standard bimetal cobalt blade / De serie hoja bimetálica al cobalto • 230 Volt - Hz 50 single-phase motor / Motor monofásico 230 Volt - Hz 50



# ABS

Automatic Blade System

## SYSTEM *REVOLUTION*

Fully autonomous cutting cycle,  
without operator.

Ciclo de corte completamente  
autónomo, sin presencia del operador.





**LASER**

**LIGHT**

**PATENTED**

**40%**  
FASTER / MÁS VELOZ

**TECHNICAL FEATURES**

- Up to 40% faster cutting compared to the traditional bandsaw thanks to the opposite rotation direction of the bandsaw blade ("NG SYSTEM")
- 5 pre-set cutting modes
- Innovative blade tensioning device with clutch to check and adjust the proper tension of the blade (patented)
- Low voltage start button power
- Adjustable left cutting angle from 0° to 45°
- Sturdy die-cast aluminium base with integrated vice

**STANDARD EQUIPMENT**







- Adjustable bar stop-rod for massproduced cuts (L=500 mm)
- Filter-circuit for electromagnetic interference damping according to rules in force



**CARACTERÍSTICAS TÉCNICAS**

- Reducción del tiempo de corte hasta un 40% respecto a una sierra tradicional gracias al sentido de rotación contrario de la hoja ("NG SYSTEM")
- 5 modos de corte programados
- Innovador tensor mediante embrague para el control y la regulación del correcto tensado de la hoja (patentado)
- Botón de inicio de baja tensión
- Ángulo de corte regulable de 0° a 45° izquierda
- Robusta base de aluminio fundido a presión con vicio integrado

**EQUIPEMENTS DE SÉRIE**

- Varilla tope regulable para realizar cortes en serie (L=500 mm)
- Circuito-filtro para la eliminación de interferencias electromagnéticas conforme con las normativas vigentes

 WATT	 mm	 Z/1"	 M/min	 a x b x h mm	 Kg
950	1335x13x0,65	8/12"	35 ÷ 80	730x390x500	17

CUTTING CAPACITY / CAPACIDAD DE CORTE			
			
0°	110x85 mm	105 mm	100x100 mm
45°	75x37 mm	74 mm	72x72 mm

\*Standard bimetal cobalt blade / De serie hoja bimetálica al cobalto  
 230 Volt - Hz 50 single-phase motor / Motor monofásico 230 Volt - Hz 50

# DCS

DIGITAL CUTTING SYSTEM

Revolutionary electronic control system that guarantees optimal cutting in the main conditions of use through 5 pre-set working modes.

Sistema revolucionario de control electrónico que asegura un corte óptimo en las principales condiciones de uso a través de 5 modos de trabajo preestablecidos.

1

For demanding cuts with particularly resistant materials, stainless steel and solid sections with thickness > 30 mm.  
Para cortes exigentes con materiales particularmente resistentes, acero inoxidable y secciones sólidas con espesor > 30 mm.

30 mt/min  
STEEL-INOX

> 30mm



2

For cutting steel with tubular sections up to 30 mm thickness and full up to 30 mm.  
Para cortar acero con secciones tubulares de hasta 30 mm de espesor y llenos hasta 30 mm.

45 mt/min  
STEEL

> 8mm < 30mm



3

Ideal for cutting iron and steel for any shape with thickness between 5 and 8 mm.  
Ideal para cortar hierro y acero de cualquier forma con espesor entre 5 y 8 mm.

55 mt/min  
STEEL

> 5mm < 8mm



4

Ideal for tubular sections including L and H sections with thin thickness from 3 to 5 mm. All materials, including aluminium.  
Ideal para secciones tubulares que incluyen secciones L y H con espesor fino de 3 a 5 mm. Todos los materiales, incluido el aluminio.

65 mt/min  
STEEL - ALU

> 3mm < 5mm



5

Only for very fine section tubulars with thicknesses under 3 mm. All materials, including aluminium.

Solo para tubulares de sección muy fina con espesores inferiores a 3 mm. Todos los materiales, incluido el aluminio.

80 mt/min  
STEEL - ALU

< 3mm



MODE

SPEED

Manual adjustment of the blade rotation speed.

Regulación manual de la velocidad de rotación de la hoja.

FORCE CONTROL

Overload indicator to avoid excessive engine strain, possible blade breakages and inaccurate cuts.

Indicator de sobrecarga para evitar la tensión excesiva del motor, posibles roturas de la hoja y cortes imprecisos.



# NG160



ART.	CODE / CÓDIGO
NG160	8.48.60.21

### TECHNICAL FEATURES

- Up to 40% faster cutting compared to the traditional bandsaw thanks to the opposite rotation direction of the bandsaw blade ("NG SYSTEM")
- Base with integrated quick sliding vice
- Powerful 2000 W single-phase motor equipped with digital electronic speed regulator "Constant Speed" with amperometric limiting device and thermal protection
- Guard safety microswitch for blade protection

### STANDARD EQUIPMENT

- Adjustable bar stop-rod for mass-produced cuts (L=500 mm)
- Handles for easy handling
- Filter-circuit for electromagnetic interference damping according to rules in force.

### CARACTERÍSTICAS TÉCNICAS

- Reducción del tiempo de corte hasta un 40% respecto a una sierra tradicional gracias al sentido de rotación contrario de la hoja ("NG SYSTEM")
- Base con mordaza y sistema deslizante rápido integrada
- Potente motor monofásico (2000 W) con regulación electrónica digital de velocidad "Constant Speed" con limitador amperimétrico y protección térmica
- Cambio de la hoja rápido y sin necesidad de herramientas.

### EQUIPEMENTS DE SÉRIE

- Varilla de sujeción regulable para realizar cortes en serie (L=500 mm)
- Asas para el transporte
- Circuito-filtro para la eliminación de interferencias electromagnéticas conforme con las normativas vigentes

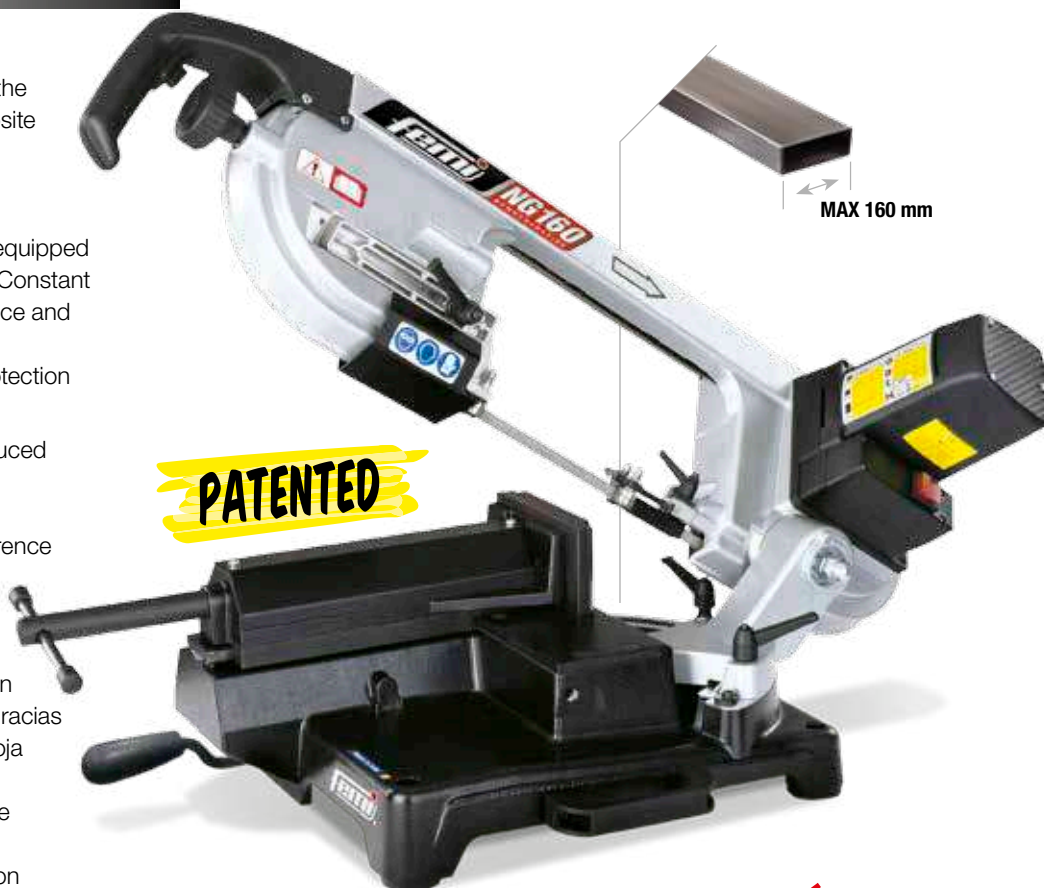

### CUTTING CAPACITY / CAPACIDAD DE CORTE

0°	160x140 mm	150 mm	150X150 mm
45°	105x120 mm	100 mm	100X100 mm

For solid materials we suggest to reduce the maximum cutting diameter  
Para el material macizo se aconseja reducir el diámetro máximo de corte



# NG

NEW GENERATION

"NG SYSTEM": opposite blade rotation direction  
"NG SYSTEM": rotación inversa de la hoja



- Adjustable double sliding saw blade guides
- Guías de corte dobles ajustables



- Innovative clutched band tensioning system (patented)
- Nuevo sistema de tensado de la hoja por fricción (patentado)



2000



1735x13x0,9



6/10\*



35 ÷ 80

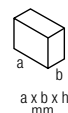

1000x390x570



35

\*Standard bimetal cobalt blade / De serie hoja bimetálica al cobalto • 230 Volt - Hz 50 single-phase motor / Motor monofásico 230 Volt - Hz 50

# NG120 XL



ART.	CODE / CÓDIGO
NG120 XL	8.48.50.22



VIDEO

## TECHNICAL FEATURES

- Up to 60% faster cutting compared to the traditional bandsaw thanks to the opposite rotation direction of the bandsaw blade ("NG SYSTEM")
- Innovative blade tensioning device with clutch to check and adjust the proper tension of the blade (patented)
- Adjustable left cutting angle from 0° to 60° with quick block at 45° and 60°
- Powerful 1300 W single-phase motor equipped with digital electronic speed regulator "Constant Speed" with amperometric limiting device
- Double front and rear sliding saw blade guides

## STANDARD EQUIPMENT

- Adjustable bar stop-rod for mass-produced cuts (L=500 mm)
- Tools for changing blade
- Filter-circuit for electromagnetic interference damping according to rules in force

## CARACTERÍSTICAS TÉCNICAS

- Reducción del tiempo de corte hasta un 60% respecto a una sierra tradicional gracias al sentido de rotación contrario de la hoja ("NG SYSTEM")
- Innovador tensor mediante embrague para el control y la regulación del correcto tensado de la hoja (patentado)
- Ángulo de corte regulable de 0° a 60° izquierda con bloqueo rápido 45° y 60°
- Potente motor 1300 W con regulación electrónica de velocidad "velocidad constante", con limitador amperimétrico y protección térmica
- Doble guía-hoja ambas deslizables anterior y posterior

## EQUIPEMENTS DE SÉRIE

- Varilla tope regulable para realizar cortes en serie (L=500 mm)
- Herramienta para el cambio de la hoja
- Circuito-filtro para la eliminación de interferencias electromagnéticas conforme con las normativas vigentes



## CUTTING CAPACITY / CAPACIDAD DE CORTE

0°	120x102 mm	120 mm	112x112 mm
45°	78x78 mm	80 mm	78x78 mm
60°	50x43 mm	50 mm	48x48 mm



# NG

NEW GENERATION

"NG SYSTEM": opposite blade rotation direction  
 "NG SYSTEM": rotación inversa de la hoja



- Maximum cutting capacity 120 x 102 mm
- Capacidad de corte máxima 120 x 102 mm



- Easy to carry
- Fácil de transportar



1300



1440x13x0,65



14\*



35 ÷ 80

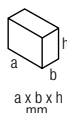

900x400x520



18

\*Standard bimetal cobalt blade / De serie hoja bimetálica al cobalto • 230 Volt - Hz 50 single-phase motor / Motor monofásico 230 Volt - Hz 50



# NG105 XL



ART.	CODE / CÓDIGO
NG105 XL	8.48.47.20

**NEW**

## TECHNICAL FEATURES

- Up to 35% faster cutting compared to the traditional bandsaw thanks to the opposite rotation direction of the bandsaw blade ("NG SYSTEM")
- Innovative blade tensioning device with clutch to check and adjust the proper tension of the blade (Patented)
- Adjustable cutting angle from 0° to 45°
- Powerful 950 Watt motor.

## STANDARD EQUIPMENT

- Adjustable bar stop-rod for mass-produced cuts (L= 500mm)
- Filter-circuit for electromagnetic interference damping according to rules in force.

## CARACTERÍSTICAS TÉCNICAS

- Reducción del tiempo de corte hasta un 35% respecto a una sierra tradicional gracias a la dirección contraria de rotación de la hoja ("NG SYSTEM")
- Innovador tensor mediante embrague para el control y regulación del correcto tensado de la hoja (patentado)
- Ángulo de corte regulable de 0° a 45°
- Potente motor 950 Watt

## EQUIPO DE SÉRIE

- Varilla de sujeción regulable para realizar cortes en serie (L= 500mm)
- Circuito-filtro para la eliminación de interferencias electromagnéticas conforme con las normativas vigentes



**WITHOUT LUBRICATION  
SIN LUBRICACION**

**FASTER 1 MÁS VELOZ  
35%**

**NG**  
NEW GENERATION

**"NG SYSTEM": opposite blade rotation direction**  
**"NG SYSTEM": rotación inversa de la hoja**

**PATENTED**



VIDEO

## CUTTING CAPACITY / CAPACIDAD DE CORTE

0°	100x85 mm	105 mm	95x95 mm
45°	65x60 mm	65 mm	65x65 mm



- The best cutting quality for any kind of material
- La mejor calidad de corte para cualquier tipo de material



- Innovative clutched band tensioning system (PATENTED)
- Nuevo sistema de tensado de la hoja por fricción (PATENTADO)



950



1335x13x0,65



14\*



60 / 80

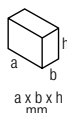

900x400x520



16

\* Standard bimetal cobalt blade / De serie hoja bimetálica al cobalto • 230 Volt - Hz 50 Single-phase motor / Motor monofásico 230 Volt - Hz 50



# NG

NEW GENERATION

## FEMI BANDSAWS WITH **PATENTED** NG CUTTING SYSTEM SIERRAS DE CINTA FEMI CON SISTEMA DE CORTE **PATENTADO**

**PATENTED**

FEMI bandsaws with **PATENTED** NG cutting system have the blade reverse direction of rotation, assuring a higher cutting speed from 35% to 60% compared to traditional saws

Las sierras de cinta FEMI con sistema de corte **PATENTADO** NG tienen el sentido de rotación inverso de la hoja, asegurando una mayor velocidad de corte del 35% hasta 60% en comparación con las sierras tradicionales

NG105XL

**35%**

NG160

**40%**

NG120XL

**60%**



**The NG SYSTEM exclusive patent enables you to save real time!**  
**¡La patente exclusiva de NG SYSTEM le permite ahorrar tiempo real!**

**NG SYSTEM** bandsaws are the **NEW GENERATION** metal cutting machines with innovative technical features unique in the world: undisputed supremacy for speed, accuracy and cutting versatility.

Las sierras de cinta **NG SYSTEM** son máquinas por el corte de los metales de **NUEVA GENERACIÓN** con características técnicas innovadoras únicas en el mundo: supremacía indiscutible en velocidad, precisión y versatilidad de corte.

**Ergonomic handle and innovative blade tensioning device (patented)**

Mango ergonómico y dispositivo tensor de hoja innovador (patentado)



**Adjustable double sliding saw blade guides**

Doble guía-hoja de ambas deslizables anterior y posterior



**Digital electronic speed regulation "constant speed"**

Regulación electrónica de velocidad digital "velocidad constante"

# 787 DA XL / 787 XL

AUTOMATIC DOWN FEED  
BAJADA AUTOMÁTICA



ART.	CODE / CÓDIGO
787 DA XL Allroad	8.48.70.25
ART.	CODE / CÓDIGO
787 XL Allroad	8.48.70.23



## TECHNICAL FEATURES

- Exclusive “roto-translating” arm system (patented) (787 XL)
- Blade height 19 mm
- Possibility to make cuts with lubrication
- Base complete with wheels ideal for transport

## STANDARD EQUIPMENT

- Circuito-filtro para la eliminación de interferencias electromagnéticas conforme con las normativas vigentes

## CARACTERÍSTICAS TÉCNICAS

- Sistema exclusiva del brazo “roto-traslación” (patentado) (787 XL)
- Altura hoja 19 mm
- Posibilidad de hacer cortes con la lubricación
- Base completa con ruedas ideal para el transporte

## EQUIPEMENTS DE SÉRIE

- Filter-circuit for electromagnetic interference damping according to rules in force

## 787 DA XL



- Control panel in ergonomic position for starting and adjusting cutting operation
- Panel de control en posición ergonómica para iniciar y ajustar las operaciones de corte



- Closed circuit hydraulic system for arm down feed and descent control
- Sistema hidráulico de circuito cerrado para control de la bajada del brazo

## CUTTING CAPACITY / CAPACIDAD DE CORTE

0°	213x150 mm	175 mm	150x150 mm
45°	145x80 mm	140 mm	140x140 mm



1850



2140X19X0,9



8/12\*



60/80

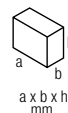

500x1300x700



59

\*Standard bimetal cobalt blade / De serie hoja bimetálica al cobalto • 230 Volt - Hz 50 single-phase motor / Motor monofásico 230 Volt - Hz 50

# 785 XL



ART.	CODE / CÓDIGO
785 XL	8.48.60.26

### TECHNICAL FEATURES

- Unique and great cutting capacity:  
 205 x 150 mm
- Powerful 1600 Watt motor with two speeds electric switchover and thermal protection
- Blade tensioning system fitted with light indicator
- Easy to carry

### STANDARD EQUIPMENT

- Adjustable bar stop-rod for massproduced cuts (L=500 mm)
- Handles for easy handling
- Filter-circuit for electromagnetic interference damping according to rules in force

### CARACTERÍSTICAS TÉCNICAS

- Gran capacidad de corte:  
 205 x 150 mm
- Potente motor 1600 W dos velocidades de conmutación eléctrica, con protección térmica
- Tensor de la hoja práctico de usar con indicador visual
- Fácil de transportar

### EQUIPEMENTS DE SÉRIE

- Varilla tope regulable, para realizar cortes en serie (L=500 mm)
- Asas para el transporte
- Circuito-filtro para la eliminación de interferencias electromagnéticas conforme con las normativas vigentes



**WITHOUT LUBRICATION  
SIN LUBRICACION**

**PATENTED**

### CUTTING CAPACITY / CAPACIDAD DE CORTE

0°	205x150 mm	152 mm	150x150 mm
45°	105x95 mm	106 mm	102x102 mm



- Exclusive "rototranslating" arm system (patented)
- Sistema exclusivo del brazo "rototraslación" (patentado).



- Ideal for cutting large profiles like conduits and profiles
- Ideal para el corte de grandes perfiles como los conductos y tubulares.



1600



1735x13x0,9



14\*



60 ÷ 80



1000x390x570



38

\*Standard bimetal cobalt blade / De serie hoja bimetálica al cobalto • 230 Volt - Hz 50 single-phase motor / Motor monofásico 230 Volt - Hz 50

# 784 XL

## XL

ART.	CODE / CÓDIGO
784 XL	8.48.50.23

### TECHNICAL FEATURES

- Innovative blade tensioning device with clutch to check and adjust the proper tensioning of the blade (patented)
- Powerful 1200 W universal motor
- Digital electronic speed regulator "Constant Speed" with amperometric limiting device
- Die-cast vice with prismatic guides
- Easy to carry: only 17 kg

### STANDARD EQUIPMENT

- Adjustable bar stop-rod for mass-produced cuts
- Tool for changing blade
- Filter-circuit for electromagnetic interference damping according to rules in force

### CARACTERÍSTICAS TÉCNICAS

- Innovador tensor mediante embrague para el control y la regulación del correcto tensado de la hoja (patentado)
- Potente motor universal 1200 W
- Regulación electrónica de velocidad "velocidad constante", con limitador amperimétrico y protección térmica
- Mordaza moldeada a presión con guías prismáticas
- Sólo 17 kg de peso para la máxima portabilidad

### EQUIPEMENTS DE SÉRIE

- Varilla tope regulable para realizar cortes en serie
- Herramienta para el cambio de la hoja
- Circuito-filtro para la eliminación de interferencias electromagnéticas conforme con las normativas vigentes



**PATENTED**

**WITHOUT LUBRICATION SIN LUBRICACION**

MAX 120 mm

**WORK TABLE AND GONIOMETER KIT (ALSO FOR ART.780XL, 782XL, 783XL ON REQUEST)**

**KIT MESA DE TRABAJO Y GONIÓMETRO (TAMBIÉN PARA ART.780XL, 782XL, 783XL BAJO PEDIDO)**



- Cutting capacity up to  $\varnothing$  120 mm and up to  $\square$  120 x 115 mm
- Capacidad de corte hasta  $\varnothing$  120 mm y hasta  $\square$  120 x 115 mm

- Powerful motor with digital electronic speed regulator
- Potente motor con regulación electrónica de velocidad

### CUTTING CAPACITY / CAPACIDAD DE CORTE

0°	120x115 mm	120 mm	119x119 mm
45°	85x70 mm	85 mm	80x80 mm

1200	1440x13x0,65	8/12*	30 ÷ 80	900x400x520	17	

\*Standard bimetal cobalt blade / De serie hoja bimetálica al cobalto • 230 Volt - Hz 50 single-phase motor / Motor monofásico 230 Volt - Hz 50

# 782 XL / 783 XL



ART.	CODE / CÓDIGO
782 XL	8.48.36.22

### TECHNICAL FEATURES

- Easy blade tensioning device
- Powerful 950 W single phase motor with digital electronic speed regulator "Constant speed" with amperometric limiting device (ART. 783XL)
- Two speeds, electronic switch (ART. 782XL).
- Anti-reset safety function
- Arm-locking device for easy handling

### STANDARD EQUIPMENT

- Adjustable bar stop-rod for mass-produced cuts (L=500 mm)
- Blade cleaning felt spares kit
- Filter-circuit for electromagnetic interference damping according to rules in force

### CARACTERÍSTICAS TÉCNICAS

- Tensor de la hoja práctico de usar
- Potente motor 950 W con regulación electrónica de velocidad "Velocidad constante", con limitador amperimétrico (ART. 783XL)
- 2 velocidades de conmutación electrónica (ART. 782XL)
- Sistema de seguridad anti-arranque
- Dispositivo de bloqueo arco para facilitar el transporte

### EQUIPEMENTS DE SÉRIE

- Varilla de sujeción de la barra regulable, para realizar cortes en serie (L=500 mm)
- Kit de recambio filtro de limpieza de la hoja
- Circuito-filtro para la eliminación de interferencias electromagnéticas conforme con las normativas vigentes



**PATENTED**

### CUTTING CAPACITY / CAPACIDAD DE CORTE

0°	100x85 mm	105 mm	95x95 mm
45°	65x60 mm	65 mm	65x65 mm

<b>782 XL</b>	950	1335x13x0,65	8/12*	60/80	730x390x500	16
<b>783 XL</b>	950	1335x13x0,65	8/12*	30 ÷ 80	730x390x500	16

\*Standard bimetal cobalt blade / De serie hoja bimetálica al cobalto • 230 Volt - Hz 50 single-phase motor / Motor monofásico 230 Volt - Hz 50



ART.	CODE / CÓDIGO
783 XL	8.48.36.23



**ELECTRONIC SPEED REGULATION**  
**REGULACIÓN ELECTRÓNICA DE VELOCIDAD**

# 782 XL - 48 VOLT



ART.	CODE / CÓDIGO
782 XI - 48 Volt	8.48.46.00

### TECHNICAL FEATURES

- 48 Volt - 560 Watt motor
- Easy blade tensioning device
- Anti reset safety function
- Cut without lubrication
- Arm locking device for an easy handling
- Thanks to 48 Volt power supply it is very suitable for:
  - shipyards or on board ship
  - underground environments

### STANDARD EQUIPMENT

- Adjustable bar stop-rod for mass-produced cuts (L=500 mm)
- Blade cleaning felt spare kit
- Filter-circuit for electromagnetic interference damping according to rules in force

### CARACTERÍSTICAS TÉCNICAS

- Motor 48 Volt - 560 Watt
- Tensor de la hoja práctico de usar
- Sistema de seguridad anti-arranque
- Corte sin lubricación
- Dispositivo de bloqueo arco para facilitar el transporte
- Gracias a la fuente de alimentación de 48 Volt, está particularmente indicado en las siguientes aplicaciones:
  - astilleros, a bordo de los barcos y plataformas off-shore
  - ambientes subterráneos

### EQUIPEMENTS DE SÉRIE

- Varilla de sujeción de la barra para realizar cortes en serie (L=500 mm).
- Kit de recambio fi eltro de limpieza de la hoja
- Circuito-filtro para la eliminación de interferencias electromagnéticas conforme con las normativas vigentes



**WITHOUT LUBRICATION  
SIN LUBRICACION**

### CUTTING CAPACITY / CAPACIDAD DE CORTE

0°	105x93 mm	105 mm	102x102 mm
45°	105x93 mm	72 mm	68x68 mm

**48 VOLT**

THANKS TO 48 VOLT POWER SUPPLY IT IS VERY SUITABLE FOR:

- SHIPYARDS OR ON BOARD SHIP
- UNDERGROUND ENVIRONMENTS

GRACIAS A LA FUENTE DE ALIMENTACIÓN DE 48 VOLT, ESTÁ PARTICULARMENTE INDICADO EN LAS SIGUIENTES APLICACIONES:

- ASTILLEROS, A BORDO DE LOS BARCOS Y PLATAFORMAS OFF-SHORE
- AMBIENTES SUBTERRÁNEOS

 WATT 560	 mm 1335x13x0,65	 Z/1° 8/12*	 M/min 70	 a x b x h mm 730X390X500	 Kg 17
-----------------	------------------------	-------------------	-----------------	---------------------------------	--------------

\*Standard bimetal cobalt blade / De serie hoja bimetálica al cobalto • 230 Volt - Hz 50 single-phase motor / Motor monofásico 230 Volt - Hz 50

# 780 XL



ART.	CODE / CÓDIGO
780 XL	8.48.33.21



VIDEO

### TECHNICAL FEATURES

- Greater cutting capacity:  $\varnothing$  105 mm
- Practical blade tensioning device
- Powerful 850W motor, 2 speeds electronically switched
- Anti-reset safety function
- Cut without lubrication
- Arm-blocking device for easy handling
- Labelling with clear cutting indications

### STANDARD EQUIPMENT

- Adjustable bar stop-rod for mass-produced cuts (L=500 mm)
- Blade cleaning felt spare kit
- Filter-circuit for electromagnetic interference damping according to rules in force

### CARACTERÍSTICAS TÉCNICAS

- Capacidad de corte mayor:  $\varnothing$  105 mm
- Tensor de la hoja práctico de usar
- Potente motor 850 W, dos velocidades de conmutación electrónica
- Sistema de seguridad anti-arranque
- Corte sin lubricación
- Dispositivo de bloqueo arco para facilitar transporte
- Forma gráfica con claras indicaciones de los parámetros de corte

### EQUIPEMENTS DE SÉRIE

- Varilla tope regulable, para realizar cortes en serie (L=500 mm)
- Kit de recambio filtro de limpieza de la hoja
- Circuito-filtro para la eliminación de interferencias electromagnéticas conforme con las normativas vigentes



### CUTTING CAPACITY / CAPACIDAD DE CORTE

0°	105x93 mm	105 mm	102x102 mm
45°	70x60 mm	72 mm	68x68 mm



- Maximum versatility of use
- Máxima versatilidad de uso



- Work table and goniometer kit (also for art. 782XL/783XL/784XL on request)
- Kit mesa de trabajo y goniómetro (también para art. 782XL/783XL/784XL bajo pedido)



850



1335x13x0,65



8/12\*



60/80

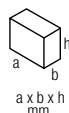

730X390X500



17

\*Standard bimetal cobalt blade / De serie hoja bimetálica al cobalto • 230 Volt - Hz 50 single-phase motor / Motor monofásico 230 Volt - Hz 50



# STANDY



ART.	CODE / CÓDIGO
390	7.13.36.87

### TECHNICAL FEATURES

- Sturdy stoved painted steel structure
- Pre-arranged to be fixed on the floor
- Maximum charge 150 kg

### CARACTERÍSTICAS TÉCNICAS

- Robusta estructura de acero pintada en caliente
- Está adaptada para ser fijada al piso
- Max posibilidad de carga: 150 kg

### UNIVERSAL TABLE BASE EXPOSITORA UNIVERSAL

ART.	CODE CÓDIGO	FOR ART. PARA ART.	Kg
390	7.13.36.87	ABS105 / ABSNG160 / ABSNG120 / 780XL / 782XL / DCS NG110 / 783XL / 784XL / NG160 / NG120XL / 785XL / NG105XL	15

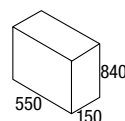

# JOBBY



ART.	CODE / CÓDIGO
300 PLUS	7.13.36.48

### TECHNICAL FEATURES

- Foldable for easy handling
- Sturdy steel section structure
- Height adjustable in three positions
- Maximum charge 50 kg

### CARACTERÍSTICAS TÉCNICAS

- Plegable para un fácil transporte
- Estructura de perfil de acero robusto
- Altura regulable en tres posiciones
- Max posibilidad de carga 50 kg

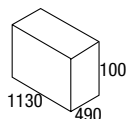

### FOLDING TABLE "JOBBY" / BANCO PLEGABLE "JOBBY"

FOR ART. / PARA ART.	Kg
ABS105 / ABSNG160 / ABSNG120 / 780XL / 782XL / DCS NG110 / 783XL / 784XL / NG160 / NG120XL / 785XL / NG105XL	11

# WORK TABLE KIT KIT MESA DE TRABAJO



CODE / CÓDIGO
7.07.51.72

### TECHNICAL FEATURES

- Alluminium work table with goniometer guides
- Equipped with anti-tips support
- Quick and easy assembly

### CARACTERÍSTICAS TÉCNICAS

- Mesa de aluminio con guías para goniómetro
- Apoyo contra vuelcos
- Montaje simple y rápido

### WORK TABLE KIT / KIT MESA DE TRABAJO

CODE CÓDIGO	FOR ART. PARA ART.
7.07.51.72	780XL / 782XL / 783XL / 784XL

# GONIOMETER FOR WORK TABLE GONIÓMETRO PARA MESA DE TRABAJO



CODE / CÓDIGO
5.13.07.52

- Cutting angle adjustment 0°-60° right-left
- Regulacion de ángulo 0°-60° de-iz



# MULTY

ART.	CODE / CÓDIGO
360	7.13.36.47



### CARATTERISTICHE TECNICHE

- Sturdy solid aluminium structure
- Universal couple of brackets for the bandsaw and mitresaw fixing
- Possibility to electrically connect three tools
- Integrated handle for an easy transport
- Side supports extensible, height and width adjustable
- Maximum charge: 120 kg

### CARACTÉRISTIQUES TECHNIQUES

- Robusta estructura en perfilado de aluminio
- Par de abrazaderas universales para fijar tronzadoras y sierra de cinta
- Posibilidad de conectar eléctricamente hasta 3 aparatos
- Empuñadura integrada para un fácil transporte
- Apoyos laterales extensibles, regulables en alto y ancho
- Max posibilidad de carga 120 kg



(cod. 7.13.06.58)

Universal brackets for fixing mitresaws and bandsaws. Additional kit on request.

Abrazaderas universales para fijar tronzadoras y SIERRA de cinta. Kit adicional bajo pedido

CODE / CÓDIGO
7.13.06.58

### FOLDING TABLE "MULTY" / BANCO PLEGABLE "MULTY"

FOR ART.	PARA ART.	Kg
ABS105 / ABSNG160 / ABSNG120 / 780XL / 782XL 48Volt / 783XL / 784XL / NG160 / NG120XL / 785XL / DCS NG110 / NG105XL		20

## SINGLE-ROLLER SUPPORT SOPORTE MONO-RODILLO

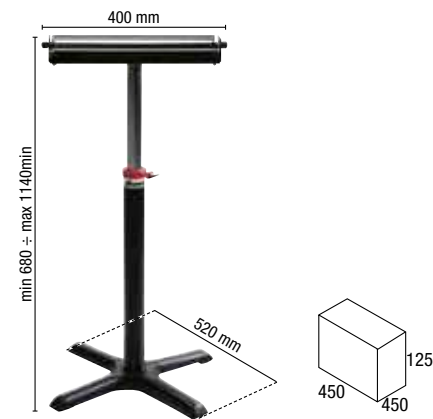

### SINGLE-ROLLER SUPPORT / SOPORTE MONO-RODILLO

ART.	CODE / CÓDIGO	WEIGHT / PESO
301	7.13.37.16	6,5 kg

### TECHNICAL FEATURES

- Zinc-plated steel roller Ø 57 mm
- Sturdy steel structure
- Base equipped with leveling feet
- Support height adjustment
- Maximum charge: 30 kg

### CARACTERÍSTICAS TÉCNICAS

- Rodillo de acero galvanizado Ø 57 mm
- Robusta estructura de acero, hierro fundido
- Base provista de pies de nivelación
- Regulación de la altura de apoyo
- Max posibilidad de carga: 30 kg

NEW

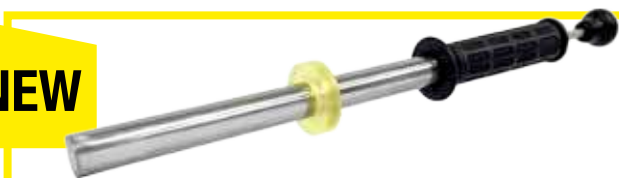

### TECHNICAL FEATURES

- Magnetic chip collector with ergonomic handle
- Stainless and lightweight shaft
- Ideal to reach hard areas
- To collect metal chips, nails and small metal components from chip-releasing machinery
- By extracting the central bar you can easily release the collected metal parts

### MAGNETIKO

CODE CÓDIGO	SIZE DIMENSIONES	WEIGHT PESO
7.07.51.95	435 mm - Ø 20 mm	650 gr

### CARACTERÍSTICAS TÉCNICAS

- Varilla magnética con mango ergonómico
- Eje inoxidable y liviano
- Ideal para zonas de difícil acceso
- Para recoger virutas de metal, clavos y pequeños componentes metálicos de la maquinaria liberadora de virutas.
- Extrayendo la barra central podrás liberar fácilmente las piezas metálicas recogidas

CODE  
CÓDIGO

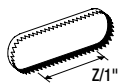

PACK  
CAJA

**ART. 787DAXL\*\*-787XL\*\* 2200**

3.27.99.36	2140x19x0,9	6/10*	1 pc.
3.27.99.39	2140x19x0,9	6/10*	5 pc.
3.28.00.24	2140x19x0,9	8/12**	1 pc.
3.28.00.25	2140x19x0,9	8/12**	5 pc.
3.27.99.38	2140x19x0,9	4/6	1 pc.
3.27.99.41	2140x19x0,9	4/6	5 pc.
3.27.99.37	2140x19x0,9	14	1 pc.
3.27.99.40	2140x19x0,9	14	5 pc.

**ART. 785XL-785P-785 1750**

3.28.99.25	1735x13x0,9	14*	1 pc.
3.27.99.28	1735x13x0,9	14*	5 pc.
3.28.99.24	1735x13x0,9	6/10	1 pc.
3.27.99.27	1735x13x0,9	6/10	5 pc.
3.28.99.26	1735x13x0,9	6	1 pc.
3.27.99.29	1735x13x0,9	6	5 pc.

**ART. 784XL-784 1440**

3.29.00.00	1440x13x0,65	8/12*	1 pc.
3.29.00.04	1440x13x0,65	8/12*	5 pc.
3.28.99.99	1440x13x0,65	14	1 pc.
3.29.00.03	1440x13x0,65	14	5 pc.
3.29.00.01	1440x13x0,65	6	1 pc.
3.29.00.05	1440x13x0,65	6	5 pc.
3.29.00.02	1440x13x0,65	18	1 pc.
3.29.00.06	1440x13x0,65	18	5 pc.

**ART. ABS 105-782XL-783XL-780XL-782XL 48 VOLT 1330**

3.28.99.48	1335x13x0,65	8/12*	1 pc.
3.27.99.20	1335x13x0,65	8/12*	5 pc.
3.28.99.49	1335x13x0,65	6	1 pc.
3.27.99.21	1335x13x0,65	6	5 pc.
3.28.99.18	1335x13x0,65	14	1 pc.
3.27.99.22	1335x13x0,65	14	5 pc.
3.28.99.19	1335x13x0,65	18	1 pc.
3.27.99.23	1335x13x0,65	18	5 pc.

\* Standard fitting on bandsaws / En dotación estándar en las SIERRA

**TECHNICAL FEATURES**

- Bimetal cobalt blades M42 for high cutting performance, suitable for dry cutting, too
- High resistance and productivity both for solid materials and for profiles
- Available in standard packs of 1 or 5 pieces

**CARACTERÍSTICAS TÉCNICAS**

- Hojas bimetálicas al cobalto M42 para elevadas prestaciones de corte, ideales también para cortes en seco
- Gran resistencia y productividad tanto en materiales macizos como en perfilados
- Disponibles en paquetes estándar de 1 ó 5 piezas



**“NG SYSTEM” Bimetal bandsaw blades**

Special blades ideal for use on “NG System” sawing machines

**“NG SYSTEM” Hojas de cinta bimetálicas**

Hojas específicas ideales para la utilización en SIERRA “NG SYSTEM”

CODE  
CÓDIGO

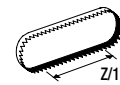

PACK  
CAJA

**ART. ABS NG160 1750**

3.28.99.65	1735x13x0,9	14*	1 pc.
3.27.99.66	1735x13x0,9	14*	5 pc.
3.28.99.63	1735x13x0,9	6/10	1 pc.
3.27.99.64	1735x13x0,9	6/10	5 pc.
3.28.99.67	1735x13x0,9	6	1 pc.
3.27.99.68	1735x13x0,9	6	5 pc.

**ART. NG160 1750**

3.28.99.63	1735x13x0,9	6/10*	1 pc.
3.27.99.64	1735x13x0,9	6/10*	5 pc.
3.28.99.65	1735x13x0,9	14	1 pc.
3.27.99.66	1735x13x0,9	14	5 pc.
3.28.99.67	1735x13x0,9	6	1 pc.
3.27.99.68	1735x13x0,9	6	5 pc.

**ART. ABS NG120-NG120XL-NG120 1440**

3.28.99.57	1440x13x0,65	14*	1 pc.
3.27.99.61	1440x13x0,65	14*	5 pc.
3.28.99.55	1440x13x0,65	8/12	1 pc.
3.27.99.59	1440x13x0,65	8/12	5 pc.
3.28.99.56	1440x13x0,65	6	1 pc.
3.27.99.60	1440x13x0,65	6	5 pc.
3.28.99.58	1440x13x0,65	18	1 pc.
3.27.99.62	1440x13x0,65	18	5 pc.

**ART. DCS NG 110-NG105 XL 1330**

3.28.00.63	1335x13x0,65	14*	1 pc.
3.28.00.67	1335x13x0,65	14*	5 pc.
3.28.00.64	1335x13x0,65	8/12	1 pc.
3.28.00.68	1335x13x0,65	8/12	5 pc.
3.28.00.65	1335x13x0,65	6	1 pc.
3.28.00.69	1335x13x0,65	6	5 pc.
3.28.00.66	1335x13x0,65	18	1 pc.
3.28.00.70	1335x13x0,65	18	5 pc.

\* Standard fitting on bandsaws / En dotación estándar en las SIERRA

**VARIABLE PITCH TOOTHING**  
**DENTADO DE PASO VARIABLE**

Tooth pitch  
Intervalo del dentado

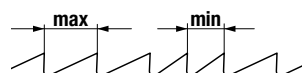

**FIXED PITCH TOOTHING**  
**DENTADO DE PASO FIJO**

1 inch - 1 pulgada  
25.4 mm

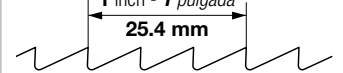

# CHOOSE YOUR BLADE! ¡ HELIGE TU HOYA



BI-METAL BAND SAW BLADES IN M42 HSS that combine excellent thermal resistance with high cutting speed. The particular structure of the blade allows it to resist bending, tension and pressure stresses.

HOJAS DE SIERRA DE CINTA BIMETÁLICAS EN M42 HSS que combinan una excelente resistencia térmica con una alta velocidad de corte. La estructura particular de la hoja le permite resistir tensiones de flexión, tensión y presión.



## SOLID MATERIALS / MATERIALES SÓLIDOS

BLADE HOJA	780XL - 782XL - 783XL - 782XL 48volt ABS 105 - DCS N G110 - NG 105XL				784XL - NG120 XL - ABS NG120				785XL - NG160 - ABS NG160		
	1335x13x0,65mm				1440x13x0,65mm				1735x13x0,9mm		
TPI (Teeth Per Inch) Dientas para inch	Z18	Z14	Z8/12	Z6	Z18	Z14	Z8/12	Z6	Z14	Z6/10	Z6
<b>Stainless Steel</b> Acero inoxidable	•	•	••	•••	•	•	••	•••	•	••	•••
<b>Cast Iron</b> Hierro fundido	•	••	•••	•••	•	••	•••	•••	•	•••	•••
<b>Iron</b> Hierro	•	•	••••	•••	•	••	••••	•••	•	••••	•••
<b>Aluminum</b> Aluminio	•	•	•••	••••	•	•	•••	••••	•	•••	••••
<b>Plastic</b> Plastico	•	••	•••	••••	•	•	•••	••••	•	•••	••••
<b>Brass</b> Latón	•	•	•••	•••	•	•	•••	•••	•	•••	•••
<b>Copper</b> Cobre	•	•	••••	•••	•	•	••••	•••	•	••••	•••

• Not recommended, •• Acceptable, ••• Good, •••• PRO Level  
• No recomendado, •• Admisible, ••• Bueno, •••• Nivel PRO

Z = Teeth Per Inch.  
Z = Dientas para inch.



## PIPES & PROFILES / TUBERIA Y PERFILES

BLADE HOJA	780XL - 782XL - 783XL - 782XL 48volt ABS 105 - DCS N G110 - NG 105XL				784XL - NG120 XL - ABS NG120				785XL - NG160 - ABS NG160		
	1335x13x0,65mm				1440x13x0,65mm				1735x13x0,9mm		
TPI (Teeth Per Inch) Dientas para inch	Z18	Z14	Z8/12	Z6	Z18	Z14	Z8/12	Z6	Z14	Z6/10	Z6
<b>Stainless Steel</b> Acero inoxidable	••••	•••	••	•	••••	•••	••	•	•••	••	•
<b>Cast Iron</b> Hierro fundido	•••	•••	••	•	•••	•••	••	•	••	•••	•
<b>Iron</b> Hierro	••••	•••	••	•	••••	•••	••	•	••••	•••	•
<b>Aluminum</b> Aluminio	•••	••	••	•	•••	••	••	•	••••	•••	•
<b>Plastic</b> Plastico	•••	••••	•••	•	•••	••••	•••	•	••••	••	•
<b>Brass</b> Latón	•••	••••	•••	•	•••	••••	•••	•	•••	•••	•
<b>Copper</b> Cobre	•••	••••	•••	•	•••	••••	•••	•	••••	•••	•

• Not recommended, •• Acceptable, ••• Good, •••• PRO Level  
• No recomendado, •• Admisible, ••• Bueno, •••• Nivel PRO

Z = Teeth Per Inch.  
Z = Dientas para inch.



**BELT SANDERS RANGE**  
GAMA LIJADORAS DE BANDA



**Bench belt sanders**  
Lijadoras de banda de banco

**PAG. 46**



**Disk sanders**  
Lijadoras de disco

**PAG. 48**



**Bench grinders with brake**  
Esmeriladoras con freno

**PAG. 49**

**BENCH GRINDERS RANGE**  
GAMA ESMERILADORAS



**Expert line**  
Linea expert

**PAG. 56**



**Tilting belt sanders**  
Lijadoras de banda inclinable

**PAG. 46**



**Belt/disk combined sanders**  
Lijadoras combinadas banda/disco

**PAG. 48**



**Linishers**  
Lijadoras

**PAG. 55**



**Horizontal Belt sanders**  
Lijadoras de banda horizontal

**PAG. 44**



**Industrial line**  
Linea Industrial

**PAG. 50**

**Bench grinder/Linishers**  
Esmeriladora/Lijadora de banda



**PAG. 54**



**Evo**  
DESIGN

**Ecological line**  
Linea ecológica

**PAG. 52**



**Sharpening Machine**  
Afiladoras

**PAG. 57**

# 577

## TECHNICAL FEATURES

- Powerful, reliable and silent induction motor - 4000 Watt
- Three phase motor 2 speeds
- Easy and quick belt replacement
- Sturdy belt tensioning system
- Working table 460 mm x 180 mm
- Belt tensioning device
- 2 operation possibilities: on table and on support

## STANDARD EQUIPMENT

- Start-stop switch with anti-reset safety fitted with mushroom button
- Possibility to be connected to an extraction system
- Zirconium Sand belt - grain 60
- Electric control panel
- Adjustable accident prevention guards
- Stainless steel column

## CARACTERÍSTICAS TÉCNICAS

- Motore de induccion, potente, silencioso y fiable - 4000 Watt
- Motor trifasico 2 velocidades
- Cambio practico y rapido de la banda
- Sistema robusto de tensión de la banda
- Mesa de trabajo 460 mm x 180 mm
- Dispositivo centrado de la banda
- 2 trabajos: en plano y en apoyo

## ÉQUIPEMENT DE SÉRIE

- Interruptor de arranque-parada con sistema de seguridad antiarranque provisto de pulsador fungiforme y de proteccion termica
- Adaptacion para equipo de aspiracion del polvo
- Banda abrasiva de zirconio - grano 60
- Cuadro de mandos electricos
- Protecciones de seguridad regulable
- Base en acero

**H 960 CM INCREASED HEIGHT FOR A BETTER AND PRACTICAL USE**

**H 960 CM ALTURA AUMENTADA PARA USO MEJOR Y MAS PRÁCTICO**



**ZIRCONIUM BELT  
GRAIN 60  
BANDA ABRASIVA DE  
ZIRCONIO GRANO 60**



ART.	CODE CÓDIGO	WATT	RPM	m/sec.	mm x mm	mm x mm	mm	Kg
577	8.26.51.30	4.000	1400/2800	15/30	150x2000	460x180	100	90

400 Volt - Hz 50 three-phase motor / Motor trifásico 400 Volt - Hz 50

**575/574**

**TECHNICAL FEATURES**

- Powerful, reliable and silent induction motor
- Easy and quick belt replacement
- Sturdy belt tensioning system
- Working table 460 mm x 75 mm
- Belt tensioning device
- 2 operation possibilities: on table and on support

**STANDARD EQUIPMENT**

- Start-stop switch with anti-reset safety fitted with mushroom button
- Possibility to be connected to an extraction system
- Zirconium Sand belt - grain 60
- Adjustable accident prevention guards
- Stainless steel column

**CARACTERÍSTICAS TÉCNICAS**

- Motore de induccion, potente, silencioso y fiable
- Cambio practico y rapido de la banda
- Sistema robusto de tensión de la banda
- Mesa de trabajo 460 mm x 75 mm
- Dispositivo centrado de la banda
- 2 trabajos: en plano y en apoyo

**ÉQUIPEMENT DE SÉRIE**

- Interruptor de arranque-parada con sistema de seguridad antiarranque provisto de pulsador fungiforme y de proteccion termica
- Adaptacion para equipo de aspiracion del polvo
- Banda abrasiva de zirconio - grano 60
- Protecciones de seguridad regulable
- Base en acero

**H 960 CM INCREASED HEIGHT FOR A BETTER AND PRACTICAL USE**  
**H 960 CM ALTURA AUMENTADA PARA USO MEJOR Y MAS PRÁCTICO**



**ZIRCONIUM BELT  
GRAIN 60**  
**BANDA ABRASIVA DE  
ZIRCONIO GRANO 60**



- Rubberized drive pulley
- Polea conductora de goma



- Belt tensioning device
- Dispositivo centrado de la banda

ART.	CODE CÓDIGO	WATT	RPM	mt/sec.	mm x mm	mm x mm	mm	Kg
575	8.26.50.30	3.000	2800	30	75x2000	460x75	60	79
574	8.26.50.20	2.200	2800	30	75x2000	460x75	60	79

230 Volt - Hz 50 single-phase motor / Motor monofásico 230 Volt - Hz 50 • 400 Volt - Hz 50 three-phase motor / Motor trifásico 400 Volt - Hz 50

542B



504B







510



338

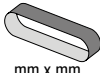
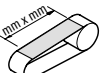
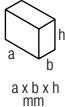

**BENCH SUPPORT (ON REQUEST)**  
**SOPORTE PARA EL BANCO (BAJO PEDIDO)**







ART.	CODE CÓDIGO	 WATT	 RPM	 mm/sec.	 mm x mm	 mm x mm	 a x b x h mm	 Kg
------	----------------	---	--	--	--	---	--	---

**BENCH BELT SANDERS / LIJADORAS DE BANDA DE BANCO**



<b>510</b>	8.26.60.31	600 	2800	16	100x1000	100X220	620x400x200	15
<b>511</b>	8.26.60.21	550 	2800	16	100x1000	100X220	620x400x200	15

 230 Volt - Hz 50 single-phase motor / Motor monofásico 230 Volt - Hz 50 •  400 Volt - Hz 50 three-phase motor / Motor trifásico 400 Volt - Hz 50

**TILTING BELT SANDERS / LIJADORAS DE BANDA INCLINABLE BANCO**

<b>542B</b>	8.26.61.33	1000 	1400	27	120x1500	160X410	1200x800x1600	52
<b>ON REQUEST VERSION WITH EXTRACTION SYSTEM (ASP 050) / BAJO PEDIDO: VERSION CON EQUIPO DE ASPIRACIÓN INTEGRADO (ASP 050)</b>								
<b>543B</b>	8.26.61.22	750 	1400	27	120x1500	160X410	1200x800x1600	52
<b>ON REQUEST VERSION WITH EXTRACTION SYSTEM (ASP 050) / BAJO PEDIDO: VERSION CON EQUIPO DE ASPIRACIÓN INTEGRADO (ASP 050)</b>								
<b>504B</b>	8.26.61.32	600/900 	1400/2800	27	120x1500	160X410	1200x800x1600	52
<b>ON REQUEST VERSION WITH EXTRACTION SYSTEM (ASP 050) / BAJO PEDIDO: VERSION CON EQUIPO DE ASPIRACIÓN INTEGRADO (ASP 050)</b>								
<b>507B</b>	8.26.62.32	1350/1600 	1400/2800	30	150x1750	200X500	1200x800x1600	67
<b>ON REQUEST VERSION WITH EXTRACTION SYSTEM (ASP 050) / BAJO PEDIDO: VERSION CON EQUIPO DE ASPIRACIÓN INTEGRADO (ASP 050)</b>								

Assembled steel column (included) / Montadas en base de acero (de serie)

 230 Volt - Hz 50 single-phase motor / Motor monofásico 230 Volt - Hz 50 •  400 Volt - Hz 50 three-phase motor / Motor trifásico 400 Volt - Hz 50

**TECHNICAL FEATURES**

- These products are aimed at industrial machining thanks to their high reliability and sturdiness
- Operation possibilities: on table, on support
- Tilting belt tale unit
- Three phase motor 2 speeds (art. 504B / art. 507B)
- Powerful, reliable and silent induction motors
- Conforming to CE Standards
- Easy and quick belt replacement

**STANDARD EQUIPMENT**

- Electric control panel (art. 510-511-542B-543B not included)
- Start-stop switch with anti-reset safety fitted with mushroom button
- Adjustable accident prevention guards
- Possibility to be connected to an extraction system
- Sand belt
- Stainless steel column with tool-holder shelf (art. 510-511 not included)

**CARACTERÍSTICAS TÉCNICAS**

- Productos orientados a trabajos industriales gracias a su gran fiabilidad y robustez
- Trabajos: en plano, en apoyo
- Aparato banda inclinable
- Motor trifásico 2 velocidades (art. 504B / art. 507B)
- Motores de inducción, potentes, silenciosos y fiables
- Conformes con las normativas CE
- Cambio práctico y rápido de la banda

**EQUIPEMENTS DE SÉRIE**

- Cuadro de mandos eléctricos (excluido ART. 510-511-542B-543B)
- Interruptor de arranque-parada con sistema de seguridad antiarranque provisto de pulsador fungiforme y de protección térmica
- Protecciones de seguridad regulable
- Adaptación para equipo de aspiración del polvo
- Banda abrasiva
- Base en acero con mesa portaobjetos (excepto art. 510-511)



**ON REQUEST VERSION WITH EXTRACTION SYSTEM (ASP 050)**

**BAJO PEDIDO: VERSION CON EQUIPO DE ASPIRACIÓN INTEGRADO (ASP 050)**



- Work on table
- Trabajo en plano



- Work on support
- Trabajo en apoyo

**TECHNICAL FEATURES**

These products are aimed at industrial machining thanks to their high reliability and sturdiness

- Operation possibilities: on table, on support
- Tilting belt and disk tale unit
- Three phase motor 2 speed
- Powerful, reliable and silent induction motors
- Conforming to CE Standards
- Easy and quick belt replacement

**STANDARD EQUIPMENT**

- Electric control panel
- Start-stop switch with anti-reset safety fitted with mushroom-shaped button
- Adjustable accident prevention guards
- Possibility to be connected to an extraction system
- Sand belt
- Stainless steel column with tool-holder shelf

**CARACTERÍSTICAS TÉCNICAS**

Productos orientados a trabajos industriales gracias a su gran fiabilidad y robustez

- Trabajos: en plano, en apoyo
- Aparato banda inclinable
- Motor trifásico 2 velocidades
- Motores de inducción, potentes, silenciosos y fiables
- Conformes con las normativas CE
- Cambio práctico y rápido de la banda

**EQUIPEMENTS DE SÉRIE**

- Cuadro de mandos eléctricos
- Interruptor de arranque-parada con sistema de seguridad antiarranque provisto de pulsador fungiforme y de protección térmica
- Protecciones de seguridad regulable
- Adaptación para equipo de aspiración del polvo
- Banda abrasiva.
- Base en acero con mesa portaobjetos

**ON REQUEST VERSION WITH EXTRACTION SYSTEM (ASP 050)**

**BAJO PEDIDO: VERSION CON EQUIPO DE ASPIRACIÓN INTEGRADO (ASP 050)**

**539B**

**525B**



**ON REQUEST VERSION WITH EXTRACTION SYSTEM (ASP 050)**

**BAJO PEDIDO: VERSION CON EQUIPO DE ASPIRACIÓN INTEGRADO (ASP 050)**

ART.	CODE CÓDIGO	WATT	RPM	mm/sec	mm x mm	mm x mm	mm	mm	Kg
------	-------------	------	-----	--------	---------	---------	----	----	----

**BELT/DISK COMBINED SANDERS / LIJADORAS COMBINADAS BANDA/DISCO**

539B	8.28.62.32	1350/1600	1400/2800	30	150X1750	200X500	435X200	400	90°÷135°	81
<b>ON REQUEST VERSION WITH EXTRACTION SYSTEM (ASP 050) / BAJO PEDIDO: VERSION CON EQUIPO DE ASPIRACIÓN INTEGRADO (ASP 050)</b>										
Assembled steel column (included) / Montadas en base de acero (de serie) - 400 Volt - Hz 50 three-phase motor / Motor trifásico 400 Volt - Hz 50										

**DISK SANDERS WITH TILTING TABLE / LIJADORAS DE DISCO CON MESA INCLINABLE**

525B	8.27.62.32	1350/1600	1400/2800	-	-	-	435X200	400	90°÷135°	52
<b>ON REQUEST VERSION WITH EXTRACTION SYSTEM (ASP 050) / BAJO PEDIDO: VERSION CON EQUIPO DE ASPIRACIÓN INTEGRADO (ASP 050)</b>										
Assembled steel column (included) / Montadas en base de acero (de serie) - 400 Volt - Hz 50 three-phase motor / Motor trifásico 400 Volt - Hz 50										

# BENCH GRINDERS WITH BRAKE ESMERILADORAS CON FRENO

All FEMI bench grinders, both with single phase and three-phase motor, can be delivered (upon request) in version with electronic PCB with brake.

The braking allows the machine to stop smoothly and in the maximum working safety.

Todas las esmeriladoras FEMI sea con motor monofasico que trifasico pueden ser entregadas (bajo pedido) en version con cuadro electrónico y tarjeta de frenado. El frenado garantiza una parada sin tirones en la máxima seguridad de utilización.

## TECHNICAL FEATURES

- Control panel complete with electronic braking PCB
- Breaking time from 4 to 8 seconds
- Anti-reset function
- Safety emergency stop button
- On / off indicator light
- Light indicator of voltage presence
- Motor thermal protection
- Motor magnetothermic protection only in 2200 W version (code 7.80.02.93)

## CARACTERÍSTICAS TÉCNICAS

- Cuadro de mandos con tarjeta electrónica de frenado
- Tiempo de frenado de 4 hasta 8 segundos
- Función antireset
- Interruptor de emergencia
- Luz indicadora arranque/parada
- Indicador luminoso de presencia de tensión
- Protección térmica del motor
- Protección magnetotérmica del motor en la versión de 2200 W (código 7.80.02.93)



CODE / CÓDIGO	DESCRIPTION / DESCRIPCIÓN	FOR ARTICLES / PARA ARTICULOS
7.80.02.91	BRAKE kit for three phase bench grinders $\geq 450$ W Kit para esmeriladoras trifasicas $\geq 450$ W	241-241/M - 243-243/M - 245-245/M - 247-247/M - 214-191-191/M - 192-192/M - 196-196/M - 197-197/M - 204 - 294N
7.80.02.92	BRAKE kit for three phase bench grinders 1100/1500 W Kit para esmeriladoras trifasicas 1100/1500 W	143-143/M - 145-145/M-163-163/M- 165-165/M - 209-193-193/M - 194-194/M- 198-198/M-199-199/M-202- and/y EVO models
7.80.02.93	BRAKE kit for three phase bench grinders 2200 W Kit para esmeriladoras trifasicas 2200 W	146-146/M-166-166/M-211-195-195/M- 200-203 and/y EVO models
7.80.02.94	BRAKE kit for single phase bench grinders $\leq 750$ W Kit para esmeriladoras monofasicas $\leq 750$ W	240-240/M-242-242/M-244-244/M-246-246/M-213 293N

The brake kit must be requested at the time of ordering and cannot be mounted at a later time.

El kit de freno debe solicitarse en el momento de realizar el pedido y no puede montarse posteriormente.

## 145/M EVO

**EVO**  
DESIGN



## 243/M

### RANGE OF DOUBLE GRINDING WHEEL BENCH GRINDERS

Sturdy and reliable are suitable for roughing-out operations and for removal of material. They can be equipped with grinding wheels of different grits.

### GAMA DE ESMERILADORAS DE DOBLE MUELA

Robustas y fiables, están indicadas para operaciones de desbastado de material. Pueden estar provistas de muelas abrasivas con grano diferenciado.



## 165/M EVO

### RANGE OF COMBINED BENCH GRINDERS (GRINDING WHEEL/BRUSH)

In addition to the features of the double grinding wheel, these bench grinders also shave and polish the workpieces. Possibility of assembling various types of grinding wheels and brushes.

### GAMA DE ESMERILADORAS COMBINADAS (MUELA/CEPILLO)

A las características de la doble muela se añade la funcionalidad para las operaciones de desbarbado y pulido de piezas. Están adaptadas para el montaje de muelas y cepillos de diferente tipo.



## 211















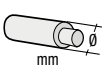
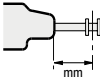
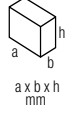























### RANGE OF POLISHING MACHINES



Ideal for use at an industrial level in the metal deburring and polishing sector. Possibility of assembling different types or brushes (metal wire or in fabric fibre, etc.).

### GAMME DE POLISSEUSES

Ideales para el uso a nivel industrial en el campo del desbarbado y pulido de metales. Están adaptadas para el montaje de cepillos de diferente tipo (filamento metálico o de fibra de tejido, etc.).



ART.	CODE CÒDIGO	 WATT	 Ø mm	 Ø mm	 RPM	 mm	 mm	 a x b x h mm	 Kg
<b>RANGE OF DOUBLE GRINDING WHEEL BENCH GRINDERS (WITH GRINDING WHEELS) / GAMA DE ESMERILADORAS DE DOBLE MUELA (PROVISTAS DE MUELAS)</b>									
240/M	8.01.31.21	450 	150x20x16	-	2800	-	-	520x210x320	11
241/M	8.01.32.31	450 	150x20x16	-	2800	-	-	520x210x320	11
242/M	8.01.33.21	750 	200x25x20	-	2800	-	-	570x290x340	18
243/M	8.01.34.31	850 	200x25x20	-	2800	-	-	570x290x340	18
143/M EVO	8.01.35.32	1100 	200x30x20	-	2800	-	-	690x280x360	22
145/M EVO	8.01.36.32	1500 	250x35x25	-	1400	-	-	720x340x420	32
146/M	8.01.87.31	2200 	300x40x30	-	1400	-	-	770x470x760	64
<b>RANGE OF DOUBLE GRINDING WHEEL BENCH GRINDERS (GRINDING WHEELS NOT INCLUDED) / GAMA DE ESMERILADORAS DE DOBLE MUELA (MUELAS NO INCLUIDAS)</b>									
240	8.01.11.21	450 	150x20x16	-	2800	-	-	520x210x320	9
241	8.01.12.31	450 	150x20x16	-	2800	-	-	520x210x320	9
242	8.01.13.21	750 	200x25x20	-	2800	-	-	570x290x340	14
243	8.01.14.31	850 	200x25x20	-	2800	-	-	570x290x340	14
143 EVO	8.01.15.32	1100 	200x30x20	-	2800	-	-	690x280x360	18
145 EVO	8.01.16.32	1500 	250x35x25	-	1400	-	-	720x340x420	27
146	8.01.67.31	2200 	300x40x30	-	1400	-	-	770x470x760	56
<b>RANGE OF COMBINED BENCH GRINDERS (COMPLETE WITH GRINDING WHEEL - BRUSH NOT INCLUDED) / GAMA DE ESMERILADORAS COMBINADAS (PROVISTAS DE MUELA - SIN CEPILLO)</b>									
244/M	8.02.31.22	450 	150x20x16	150x25x16	2800	16	90	520x210x320	11
245/M	8.02.32.32	450 	150x20x16	150x25x16	2800	16	90	520x210x320	11
246/M	8.02.33.21	750 	200x25x20	200x25x16	2800	16	90	570x290x340	16
247/M	8.02.34.31	850 	200x25x20	200x25x16	2800	16	90	570x290x340	16
163/M EVO	8.02.35.31	1100 	200x30x20	200x30x20	2800	20	130	690x280x360	24
165/M EVO	8.02.36.32	1500 	250x35x25	250x30x20	1400	20	135	720x340x420	30
166/M	8.02.87.31	2200 	300x40x30	300x35x25	1400	25	190	1000x400x760	60
<b>RANGE OF COMBINED BENCH GRINDERS (WHEEL AND BRUSH NOT INCLUDED) / GAMA DE ESMERILADORAS COMBINADAS (MUELA Y CEPILLO NO INCLUIDOS)</b>									
244	8.02.11.22	450 	150x20x16	150x25x16	2800	16	90	520x210x320	10
245	8.02.12.32	450 	150x20x16	150x25x16	2800	16	90	520x210x320	10
246	8.02.13.21	750 	200x25x20	200x25x16	2800	16	90	570x290x340	14
247	8.02.14.31	850 	200x25x20	200x25x16	2800	16	90	570x290x340	14
163 EVO	8.02.15.32	1100 	200x30x20	200x30x20	2800	20	130	690x280x360	20
165 EVO	8.02.16.32	1500 	250x35x25	250x30x20	1400	20	135	720x340x420	22
166	8.02.67.31	2200 	300x40x30	300x30x25	1400	25	190	1000x400x760	54
<b>RANGE OF POLISHING MACHINES (BRUSHES NOT INCLUDED) / GAMA DE PULIDORAS (CEPILLOS NO INCLUIDOS)</b>									
213	8.04.13.21	750 	-	200x25x16	2800	16	90	630x240x320	14
214	8.04.14.31	850 	-	200x25x16	2800	16	90	630x240x320	14
209 EVO	8.04.15.32	1100 	-	250x30x20	2800	20	135	850x290x390	27
211	8.04.57.31	2200 	-	300x35x25	2800	25	190	1200x400x760	50

 230 Volt - Hz 50 single-phase motor / Motor monofásico 230 Volt - Hz 50 •  400 Volt - Hz 50 three-phase motor / Motor trifásico 400 Volt - Hz 50

**TECHNICAL FEATURES AND STANDARD EQUIPMENT**

**These products are suitable for industrial purposes**

- These products are suitable for industrial purposes
- 5 years warranty
- Powerful, reliable and silent induction motors
- Integrated safety thermal protection (for motors > 500 W)
- According to CE Standards
- Complete with accident prevention guards and suction fittings
- Switch with anti-reset safety function and padlockable mushroom button
- Standard control panel and cast iron body (ART. 146-146/M-166-166/M-211)

**CARACTERÍSTICAS TÉCNICAS Y EQUIPAMIENTO DE SERIE**

**Productos orientados a trabajos industriales gracias a su gran robustez**

- Productos orientados a trabajos industriales gracias a su gran robustez
- 5 años de garantía
- Potentes motores de inducción, fiables y silenciosos
- Protección térmica de seguridad integrada (para motores > 500 W).
- Conformes con las normativas CE
- Provistas de protección para prevención de accidentes y toma para aspiración
- Provistas de interruptor arranque-parada con sistema de seguridad anti-arranque y pulsador fungiforme con posibilidad de bloqueo
- Cuadro de mandos de serie y cuerpo de hierro fundido (ART. 146-146/M-166-166/M-211)

## 199/M EVO

### RANGE OF COMBINED ECOLOGICAL BENCH GRINDERS

In addition to the features of the double grinding wheel, these bench grinders also deburring and polish the workpieces. Possibility of assembling various types of grinding wheels and brushes.

### GAMA DE ESMERILADORAS COMBINADAS ECOLÓGICAS

A las características de la doble muela se añade la funcionalidad para operaciones de desbarbado y pulimento de piezas. Están adaptadas para el montaje de muelas y cepillos de diferente tipo.

**Evo**  
DESIGN



## 192/M

### RANGE OF DOUBLE GRINDING WHEEL ECOLOGICAL BENCH GRINDER

Designed with a view to fully comply with workplace health and safety regulations thanks to the extraction system provided, built-into the base. They can be equipped with grinding wheels with different grits.

### GAMA DE ESMERILADORAS ECOLÓGICAS DE DOBLE MUELA

Concebidas en el total respeto de las normas de seguridad e higiene del ambiente de trabajo, gracias a la presencia del sistema de aspiración integrado en la base. Pueden estar provistas de muelas abrasivas con grano diferenciado.



## 203





























### RANGE OF ECOLOGICAL POLISHING MACHINES

Designed for industrial polishing operations fully complying with safety and environmental regulations. Possibility of assembling different types of brushes (metal wire, etc.).



### GAMA DE PULIDORAS ECOLÓGICAS

Concebidas para operaciones de pulimento industrial con pleno respeto de la seguridad y del ambiente. Están adaptadas para el montaje de cepillos de diferente tipo (filamento metálico, etc.).

ART.	CODE CÓDIGO	 WATT	 Ø mm	 Ø mm	 RPM		DUST COLLECTOR ASPIRADOR	 Kg	
<b>RANGE OF DOUBLE GRINDING WHEEL ECOLOGICAL BENCH GRINDERS (WHEELS INCLUDED) / GAMA DE ESMERILADORAS ECOLÓGICAS DE DOBLE MUELA (PROVISTAS DE MUELAS)</b>									
191/M	8.00.31.31	450 	150x20x16	-	2800	-	ASP 020	34	
192/M	8.00.33.31	850 	200x25x20	-	2800	-	ASP 020	38	
193/M EVO	8.00.35.32	1100 	200x30x20	-	2800	-	ASP 020	48	
194/M EVO	8.00.39.32	1500 	250x35x25	-	1400	-	ASP 020	55	
195/M	8.00.43.31	2200 	300x40x20	-	1400	-	ASP 020	93	
<b>RANGE OF COMBINED ECOLOGICAL BENCH GRINDERS (GRINDING WHEELS NOT INCLUDED) / GAMA DE ESMERILADORAS ECOLÓGICAS DE DOBLE MUELA (MUELAS NO INCLUIDAS)</b>									
191	8.00.30.31	450 	150x20x16	-	2800	-	ASP 020	29	
192	8.00.32.31	850 	200x25x20	-	2800	-	ASP 020	34	
193 EVO	8.00.34.32	1100 	200x30x20	-	2800	-	ASP 020	39	
194 EVO	8.00.38.32	1500 	250x35x25	-	1400	-	ASP 020	46	
195	8.00.13.31	2200 	300x40x20	-	1400	-	ASP 020	85	
<b>RANGE OF COMBINED ECOLOGICAL BENCH GRINDERS (COMPLETE WITH GRINDING WHEEL - BRUSH NOT INCLUDED) / GAMA DE ESMERILADORAS COMBINADAS ECOLÓGICAS (PROVISTAS DE MUELA - CEPILLO NO INCLUIDOS)</b>									
196/M	8.00.51.32	450 	150x20x16	150x25x16	2800	90	ASP 020	32	
197/M	8.00.53.31	850 	200x25x20	200x25x16	2800	90	ASP 020	37	
198/M EVO	8.00.55.32	1100 	200x30x20	200x30x20	2800	130	ASP 020	47	
199/M EVO	8.00.59.32	1500 	250x35x25	250x30x20	1400	135	ASP 020	52	
200/M	8.00.63.31	2200 	300x40x30	300x35x30	1400	190	ASP 020	91	
<b>RANGE OF COMBINED ECOLOGICAL BENCH GRINDERS (WHEEL AND BRUSH NOT INCLUDED) / GAMA DE ESMERILADORAS COMBINADAS ECOLÓGICAS (MUELA Y CEPILLO NO INCLUIDOS)</b>									
196	8.00.50.32	450 	150x25x16	150x25x16	2800	90	ASP 020	30	
197	8.00.52.31	850 	200x25x20	200x25x16	2800	90	ASP 020	36	
198 EVO	8.00.54.32	1100 	200x30x20	200x30x20	2800	130	ASP 020	41	
199 EVO	8.00.58.32	1500 	250x35x25	250x30x20	1400	135	ASP 020	48	
200	8.00.18.31	2200 	300x40x30	300x35x25	1400	190	ASP 020	87	
<b>RANGE OF ECOLOGICAL POLISHING MACHINES (BRUSHES NOT INCLUDED) / GAMA DE PULIDORAS ECOLÓGICAS (CEPILLOS NO INCLUIDOS)</b>									
204	8.00.71.31	850 	-	200x25x16	2800	90	ASP 020	34	
202 EVO	8.00.72.32	1100 	-	250x30x20	2800	135	ASP 020	49	
203	8.00.29.31	2200 	-	300x35x25	2800	190	ASP 020	98	

 400 Volt - Hz 50 three-phase motor / Motor trifásico 400 Volt - Hz 50

### TECHNICAL FEATURES AND STANDARD EQUIPMENT

**Products suitable for industrial purposes thanks to their high reliability and sturdiness**

- Three-phase electric motor equipped with safety thermal protection (for motors > 500 w)
- Standard integrated dust extractor
- 5 years warranty
- Equipped with removable water reservoir, built-in suction system fit with self-extinguishing filter-bag
- Powerful, reliable and silent induction motors
- According to CE Standards
- Complete with accident prevention guards
- START-STOP switch with anti-reset safety function and padlockable mushroom-shaped button
- Standard control panel and cast iron body (ART.195, 195/M, 200, 200/M, 203)

### CARACTERÍSTICAS TÉCNICAS Y EQUIPAMIENTO DE SERIE

**Productos orientados a trabajos industriales gracias a su gran fiabilidad y robustez**

- Motores eléctricos trifásicos provistos de protección térmica de seguridad (para motores > 500 w)
- Equipo de aspiración integrado de serie
- 5 años de garantía
- Potentes motores de inducción, fiables y silenciosos
- Conformes con las normativas CE
- Provistas de protección para prevención de accidentes y toma para aspiración
- Provistas de interruptor arranque-parada con sistema de seguridad anti-arranque y pulsador fungiforme con posibilidad de bloqueo
- Cuadro de mandos de serie y cuerpo de hierro fundido (ART.146-146/M-166-166/M-211)

**294N**  
**293N**



- Zirconium belt grain 60 standard fitting
- Banda abrasiva de circonio grano 60 equipo estándar



**BENCH GRINDERS/LINISHERS**

Sturdy and reliable, this article combines the versatility of the liners to the traditional grinding wheel.

**ESMERILADORA/LIJADORA DE BANDA**

Robusta y fiable, une a la tradicional muela abrasiva, la versatilidad de las lijadoras de banda.



**TECHNICAL FEATURES AND STANDARD EQUIPMENT**







Reliable products suitable for industrial purposes owing to the high quality components used.

- 5 years warranty
- Possibility to work both on the table and on the rubber-coated wheel
- Powerful and silent motors equipped with safety thermal protection
- According to CE Standards
- START-STOP switch with anti-reset safety function and padlockable mushroom-shaped button
- Easy and practical belt replacement
- Tilting belt unit
- Adjustable accident prevention guards equipped with suction fitting
- Complete with grinding wheel and sand belt

**CARACTERISTICAS TÉCNICAS Y EQUIPAMIENTO DE SERIE**

Productos fiables orientados a trabajos industriales gracias a la gran calidad de los componentes utilizados.

- 5 años de garantía
- Trabajos en la mesa de apoyo y sobre la pulea de goma
- Motores potentes y silenciosos provistos de protección térmica de seguridad
- Conformes con las normativas CE
- Provistas de interruptor arranque-paraada con sistema de seguridad anti-arranque y pulsador fungiforme con posibilidad de bloqueo
- Sustitución práctica y rápida de la banda
- Aparato banda inclinable
- Protecciones de seguridad regulables provistas de unión para aspiración
- Provistas de muelas y bandas abrasivas

ART.	CODE CÓDIGO	 WATT	 RPM	 mm x mm	 Ø mm
<b>294N</b>	<b>8.07.10.31</b>	850 	2800	100x1000	200x25x20
<b>293N</b>	<b>8.07.10.21</b>	750 	2800	100x1000	200x25x20

\* Column ART.303 available on request / Base Art.303 disponible bajo pedido

 400 Volt - Hz 50 three-phase motor / Motor trifásico 400 Volt - Hz 50

 230 Volt - Hz 50 single-phase motor / Motor monofásico 230 Volt - Hz 50





**Evo**  
DESIGN

**TECHNICAL FEATURES E STANDARD EQUIPMENT**

**Reliable products suitable for industrial purposes owing to the high quality components used**

- 5 years warranty
- Possibility to work both on the table and on the rubbercoated wheel
- Powerful and silent motors equipped with safety thermal protection
- According to CE Standards
- START-STOP switch with anti-reset safety function and padlockable mushroom-shaped button
- Easy and practical belt replacement
- Tilting belt unit
- Adjustable accident prevention guards equipped with suction fitting
- Complete with grinding wheels and sand belts

**CARACTERÍSTICAS TÉCNICAS Y**

**EQUIPAMIENTO DE SERIE**

**Productos fiables orientados a trabajos industriales gracias a la gran calidad de los componentes utilizados**

- 5 años de garantía
- Trabajos en la mesa de apoyo y sobre la polea de goma
- Motores potentes y silenciosos provistos de protección térmica de seguridad
- Conformes con las normativas CE
- Provistas de interruptor arranque-parada con sistema de seguridad anti-arranque y pulsador fungiforme con posibilidad de bloqueo
- Sustitución práctica y rápida de la banda
- Aparato banda inclinable
- Protecciones de seguridad regulables provistas de unión para aspiración
- Provistas de muelas y bandas abrasivas

**296 EVO**

**BENCH GRINDERS/LINISHERS**

Sturdy and reliable, this article combines the versatility of the linishers to the traditional grinding wheel.

**ESMERILADORA/LIJADORA DE BANDA**

Robusta y fiable, une a la tradicional muela abrasiva, la versatilidad de las lijadoras de banda.



**298 EVO**

**LINISHERS**

Equipped with different grits belt equipment and mobile surrounding guards. Its ideal use is for shaving operations and foundry casting treatment owing to the high peripheral speed of the belt.

**LIJADORA DE BANDA**

Provista de banda de lija de grano diferenciado, está equipada con protecciones integrales móviles. Es sumamente adecuada para las operaciones de desbarbado y tratamiento de fundiciones gracias a la elevada velocidad periférica de la banda.



**303**

**COLUMN (ON REQUEST)  
BASE (BAJO PEDIDO)**

ART.	CODE CÒDIGO	WATT	RPM	mm x mm	Ø mm
<b>BENCH GRINDER/LINISHERS / ESMERILADORA/LIJADORA DE BANDA</b>					
<b>296* EVO</b>	<b>8.06.10.32</b>	1100	2800	50x2200	200X25x20
<b>LINISHER / LIJADORA DE BANDA</b>					
<b>298* EVO</b>	<b>8.06.11.32</b>	1100	2800	50x2200	-

\* Column ART.303 available on request / Base Art.303 disponible bajo pedido  
 400 Volt - Hz 50 three-phase motor / Motor trifásico 400 Volt - Hz 50

**404**

**BENCH GRINDERS DOUBLE WHEEL Ø 150**  
ESMERILADORAS DOBLE MUELA Ø 150



**405**

**BENCH GRINDERS DOUBLE WHEEL Ø 200**  
ESMERILADORAS DOBLE MUELA Ø 200



**424**

**COMBINED BENCH GRINDERS Ø 150**  
ESMERILADORAS COMBINADAS Ø 150



**425**

**COMBINED BENCH GRINDERS Ø 200-150**  
ESMERILADORAS COMBINADAS Ø 200-150



**TECHNICAL FEATURES E STANDARD EQUIPMENT**

- Reliable and silent induction motors
- Equipped with accident prevention guards and suction fitting (not contemplated for ART. 404-424)
- Equipped with START-STOP switch with anti-reset safety function
- Complete with grinding wheels and steel brushes (ART. 424 and 425)
- Possibility of being applied to the steel column ART. 303

**CARACTERISTICAS TÉCNICAS Y EQUIPAMIENTO DE SERIE**

- Motores de inducción, fiables y silenciosos
- Provistas de protecciones para prevención de accidentes y unión para aspiración (no previsto para ART. 404 y 424)
- Provistas de interruptor arranque-parada con sistema de seguridad anti-arranque
- Equipadas con muelas abrasivas y cepillos de acero (ART. 424 y 425)
- Adaptadas para aplicaciones sobre base de acero ART. 303

ART.	CODE CÒDIGO	WATT	Ø mm	Ø mm	RPM	a x b x h mm	Kg
404	8.01.54.20	370	150x20x16	-	2800	520x210x320	10
405	8.01.56.20	500	200x20x16	-	2800	570x290x340	15
424	8.02.54.20	370	150x20x16	150x20x16	2800	520x210x320	12
425	8.02.56.20	500	200x20x16	150x20x16	2800	520x290x340	15

⚡ 230 Volt - Hz 50 single-phase motor / Motor monofásico 230 Volt - Hz 50

# 182 PLUS

ART.	CODE / CÓDIGO
182 PLUS	8.13.23.21



## COMBINED SHARPENING MACHINE

Machine equipped with two grinding wheels that rotate at differentiated speed; grinding wheel suitable for all the common grinding and shaving operations; slow-turning water bath sharpening wheel for sharpening scissors, knives, chisels and blades in general.

### TECHNICAL FEATURES

- Reliable and silent induction motors
- Conforming to CE Standards

### STANDARD EQUIPMENT

- Accident prevention guards
- Wheel wiper brush
- High quality white corundum sharpening unit with large grinding wheel
- Sharpening and grinding wheels

## AFILADORA COMBINADA

Máquina provista de dos muelas coaxiales giratorias de velocidad diferenciada; muela esmeriladora apta para todas las operaciones de esmerilado y desbarbado; muela afiladora de vueltas lentas en baño de agua que permite afilar tijeras, cuchillos, cinceles y todo tipo de hoja en general.

### CARACTERÍSTICAS TÉCNICAS

- Motores de inducción, fiables y silenciosos
- Conforme con las normativas CE

### EQUIPAMIENTO DE SERIE

- Protecciones para prevención de accidentes
- Cepillo limpiamuela
- Grupo de afilado con muela de grandes dimensiones de corindón blanco fino
- Muela esmeriladora



500 WATT 150x20x16 2800 RPM 180x30x20 200 RPM 400x255x250 Kg 10

230 Volt - Hz 50 single-phase motor  
Motor monofásico 230 Volt - Hz 50

# 177

ART.	CODE / CÓDIGO
177	8.13.22.21



## WATER-OPERATED SHARPENING MACHINE

Single-wheel professional sharpening machine with ABS shockproof structure equipped with high quality white corundum wheel partially soaked in water for the perfect sharpening of all types of blades and cutting tools.

### TECHNICAL FEATURES E STANDARD EQUIPMENT

- Reliable and silent induction motor
- High quality white corundum sharpening wheel
- Double safety insulation

## AFILADORA DE AGUA

Afiladora profesional mono-muela con estructura de ABS antichoque provista de muela de corindón fino blanco parcialmente sumergido en agua para garantizar el perfecto afilado de todos los tipos de hojas y herramientas de corte.

### CARACTERÍSTICAS TÉCNICAS Y EQUIPAMIENTO DE SERIE

- Motor de inducción, fiable y silencioso
- Muela afiladora de corindón blanco fino
- Doble aislamiento de seguridad



150 WATT 200x40x20 120 RPM 425x275x270 Kg 6,5

230 Volt - Hz 50 single-phase motor  
Motor monofásico 230 Volt - Hz 50

# COLUMNS / BASES



**303**



**308N**



**338**

### TECHNICAL FEATURES

Sturdy column in pressed and shaped steel fitter with removable water reservoir for tool cooling.

### CARACTERÍSTICAS TÉCNICAS

Robusta base de acero estampado y perfilado provista de recipiente para agua, desmontable para el enfriamiento de las herramientas.

ART.	CODE / CÓDIGO	FOR ARTICLES / PARA ARTICULOS
303	7.13.35.06	143-143/M-145-145/M-163-163/M-165-165/M-208-209-213-214-240-240M - 241-241/M-242-242/M-243-243/M-244-244/M-245-245/M-246-246/M - 247-247/M-282-296-298-404-405-424-425
303+ASP020	7.13.35.97	+ EVO models 293N-294N
304	7.13.35.07	
304+ASP020	7.13.35.98	146-146/M-166-166/M-211
338	7.13.36.50	510-511
308N	7.13.35.83	All belt sanders - Todos las lijadoras



### CONTROL PANEL - ULTRA-LOW TENSION (24 V) / CUADRO DE MANDOS - DE BAJISIMA TENSIÓN (24 V)

CODE / CÓDIGO	DESCRIPTION / DESCRIPCIÓN
7.80.02.27	For bench grinders WATT 450-850 / Para esmeriladoras WATT 450-850
7.80.02.30	For bench grinders WATT 1100-1500 / Para esmeriladoras WATT 1100-1500
7.80.02.31	For bench grinders WATT 2200 / Para esmeriladoras WATT 2200
7.80.02.32	For 1-speed belt sanders / Para lijadoras 1 velocidad
7.80.02.29	For 2-speed belt sanders / Para lijadoras 2 velocidades

The control panel is equipped with a 24-Volt transformer, magnetothermal circuit breaker, emergency mushroom-shaped button, start/stop buttons and power LED. IP 55 insulation class. Complete with support for assembly operations. Particularly suitable for technical schools, public bodies and industries for absolute safety.

Cuadro de mandos provisto de transformador 24 V, interruptor magnetotérmico, pulsador fungiforme de emergencia, pulsadores de marcha/parada y testigo luminoso de tensión. Grado de protección IP 55. Provisto de soporte para el montaje. Especialmente adecuado para institutos técnicos, entes estatales e industriales por la absoluta seguridad.









### CONTROL PANEL / CUADRO DE MANDOS



CODE / CÓDIGO	DESCRIPTION / DESCRIPCIÓN
7.80.02.07	Control panel for bench grinders WATT 450-750 Cuadro de mandos para esmeriladoras WATT 450-700
7.80.02.08	Control panel for bench grinders WATT 450-850 Cuadro de mandos para esmeriladoras WATT 450-850
7.80.02.09	Control panel for bench grinders WATT 1100-1500 Cuadro de mandos para esmeriladoras WATT 1100-1500
7.80.02.13	For belt sanders / Para lijadoras 510 - 542B
7.80.02.16	For belt sanders / Para lijadoras 511 - 543B

Control panel equipped with magnetothermal circuit breaker and emergency mushroom-shaped button. Insulation class. Complete with support for assembly operations.

Cuadro de mandos provisto de interruptor magnetotérmico y pulsador fungiforme de emergencia. Grado de protección IP 55. Provisto de soporte para el montaje.

ART.	CODE CÓDIGO	 WATT	 M³/h	 press. mm H <sub>2</sub> O	 Ø mm	FOR ARTICLES / PARA ARTICULOS
<b>CENTRIFUGAL DUST COLLECTORS / ASPIRADORES CENTRIFUGOS</b>						
ASP 020	7.11.20.10	150 	410	95	35	143-143/M-145-145/M-146-146/M-163-163/M-165-165/M-166-166/M - 208-209-211-213-214-240-240/M-241-241/M-242-242/M-243-243/M - 244-244/M-245-245/M-246-246/M-247-247/M- 282-296-298-510-511 + EVO models
	7.11.20.51*					577 - 575
ASP 020	7.11.20.57	150 	410	95	35	577 - 575
	7.11.20.58		410	95	35	574
ASP 050	7.11.20.12	370 	980	120	90	542B-543B-504B-505B-507B-522B-525B-534B-535B - 536B-537B-539B-502-503-504
	7.11.20.52*					

\* Delivered installed on the column (column non included) - Provistos de montaje en la base de la máquina (base no incluida)

**CENTRIFUGAL DUST COLLECTORS\***

Suitable for extracting metallic dust coming from the grinding, sanding and polishing processes. Complete with coupling flange for being assembled onto columns 303, 303E and 304 (bench grinders) and 308/N (belt sanders). Fitted with filter bag made of self-extinguishing fabric. Version ASP 020 is provided with 2 suction air inlets for pipes Ø 35 (450 W - 750 W - 1100 W - 1500 W bench grinders). Inlets are also available for pipes with Ø 50 (2200 W bench grinders) and Ø 60 (polishing machines). All the suction inlets in the ASP 050 version are for pipes Ø 90 (belt sanders)

\*THREE-PHASE 400 VOLT - STANDARD / SINGLE PHASE 230 VOLT - ON REQUEST



**ASPIRADORES CENTRÍFUGOS\***

Aptos para la aspiración y la recogida de polvos metálicos provenientes de trabajos de esmerilado, lijado y pulido. Provistos de brida de acoplamiento para el montaje sobre las bases 303, 303E y 304 (esmeriladoras) y 308/N (lijadoras). Con bolsa filtro recogedor de hebra autoextinguible. En la versión ASP. 020 están incluidas dos bocas de aspiración para tubos Ø 35 (esmeriladoras 450 W - 750 W - 1100 W - 1500 W). También están disponibles bocas para tubos Ø 50 (esmeriladoras 2200 W) y Ø 60 (pulidoras). En la versión ASP 050 las bocas de aspiración son todas para tubo de Ø 90 (lijadoras)

\*TRIFÁSICO 400 VOLT - DE SERIE / MONOFÁSICO 230 VOLT - BAJO PEDIDO

**DUST FILTER-BAGS. IN SELF-EXTINGUISHING FABRIC  
BOLSAS-FILTRO DE RECOGIDA DEL POLVO. DE MATERIAL AUTOEXTINGUIBLE**

CODE CÓDIGO	FOR ARTICLES PARA ARTICULOS
5.07.32.05	ASP 020
5.07.32.06	ASP 050



**ADAPTERS  
BOCAS ASPIRACIÓN**

CODE CÓDIGO	FOR PIPES / PARA TUBOS Ø MM	FOR ARTICLES PARA ARTICULOS
5.24.13.28	35	ASP 020
5.24.13.20	50	ASP 020
5.24.13.21	60	ASP 020





**ALUMINIUM PIPES FOR DUST COLLECTORS  
TUBOS DE ALUMINIO PARA ASPIRADORES**

CODE CÓDIGO	Ø mm	MINIMUM ORDER (MT) PEDIDO MÍNIMO (MT)
1.95.35.01	35	3
1.95.50.01	50	3
1.95.60.01	60	3
1.95.90.02	90	3
1.95.99.02	100	3







## WHEELS, SAND BELT AND BRUSHES FOR INDUSTRIAL RANGE / MUELAS, BANDAS ABRASIVAS Y CEPILLOS PARA SERIE INDUSTRIAL

CODE CÓDIGO	 Ø mm	 Ø mm	 mm x mm	GRAIN GRANO	PIECES NR. PIEZAS N°	FOR ART. PARA ART.
<b>IN SINGLE PACK / EN PAQUETE UNITAR</b>						
3.22.99.23	150x20x16/12*/12,7*		-	36	1	191-191/M-196-196/M-240-240/M-241-241/M-244-244/M-245-245/M
3.22.99.24	150x20x16/12*/12,7*		-	60	1	191-191/M-196-196/M-240-240/M-241-241/M-244-244/M-245-245/M
3.22.99.30	200x25x20		-	36	1	192-192/M-197-197/M-242-242/M-243-243/M-246-246/M-247-247/M-296-293N-294N
3.22.99.31	200x25x20		-	60	1	192-192/M-197-197/M-242-242/M-243-243/M-246-246/M-247-247/M-296-293N-294N
3.22.99.32	200x30x20		-	36	1	143-143/M-163-163/M-193-193/M-198-198/M
3.22.99.33	200x30x20		-	60	1	143-143/M-163-163/M-193-193/M-198-198/M
3.22.12.61	250x35x25		-	36	1	145-145/M-165-165/M-194-194/M-199-199/M
3.22.13.59	250x35x25		-	60	1	145-145/M-165-165/M-194-194/M-199-199/M
3.22.11.75	300x40x30		-	24	1	146-146/M-166-166/M-195-195/M-200-200/M
3.22.12.74	300x40x30		-	46	1	146-146/M-166-166/M-195-195/M-200-200/M
3.23.99.40	-	200x25x16	-	60	1	246 - 246/M - 247 - 247/M - 213 - 214 - 167 - 197/M - 204
3.23.99.41	-	200x30x20	-	60	1	163 EVO - 163 M EVO - 198 EVO - 198 M EVO
3.23.99.42	-	250x30x20	-	60	1	165 EVO - 165 M EVO - 209 EVO - 199 EVO - 199/M EVO - 202 EVO
3.23.99.43	-	300x35x25	-	60	1	166 - 166/M - 211 - 200 - 200/M - 203
<b>SAND BELTS / BANDAS ABRASIVAS EN PAQUETE ESTÁNDAR</b>						
3.23.99.17	-		50x2200	40	10	296-298
3.23.99.18	-		50x2200	60	10	296-298
3.23.99.19	-		50x2200	80	10	296-298

\*With reduction bushing included in the packaging / \*Con reducciones incluidas

## WHEELS, BRUSHES AND SANDING BELTS PROFESSIONAL RANGE / MUELAS, CEPILLOS Y BANDAS ABRASIVAS PARA SERIE PROFESIONAL

CODE CÓDIGO	 Ø mm	 Ø mm	 Ø mm	 mm x mm	GRAIN GRANO	PIECES NR. PIEZAS N°	FOR ART. PARA ART.
3.22.99.23	150x20x16/12*/12,7*	-	-	-	36	1	404-424-182PLUS
3.22.99.24	150x20x16/12*/12,7*	-	-	-	60	1	404-424-182PLUS
3.22.99.25	200x20x16	-	-	-	36	1	405 - 425
3.22.99.26	200x20x16	-	-	-	60	1	405 - 425
3.22.99.28	-	180x30x20	-	-	150	1	182 PLUS
3.22.99.27	-	200x40x20	-	-	150	1	177
3.23.99.35	-	-	150x20x16	-	-	1	424-425

\*With reduction bushing included in the packaging / \*Con reducciones incluidas

## WHEELS, BRUSHES AND SANDING BELTS

Disk grinding wheels either made of gray corundum (carborundum) and ceramics binder (bench grinders) or of high quality white corundum and glazed ceramics binder (sharpening machines). Corundum sand belts, high resistance reinforced fabric support and ground joints for greater smoothness. Grinding wheels and belts available in different grits: the higher the number the finer the grit (suitable for deburring and finishing), whereas the lower the number the rougher the grit (suitable for grinding and roughing-out).

## MUELAS, CEPILLOS Y BANDAS

Muelas de disco de corindón gris (carburo de silicio) y aglutinante cerámico (esmeriladoras) o bien de corindón fino blanco y aglutinante cerámico vitrificado (afiladoras).

Bandas abrasivas de corindón, soporte de tela reforzada de gran resistencia,

Uniones lijadas para garantizar un mayor deslizamiento. Muelas y bandas disponibles en diferentes granos: a un número más alto corresponde un grano más fino (ideal para desbarbados y acabados), mientras que a un número más bajo corresponde un grano más grueso (ideal para esmerilado y desbastado).



**SANDING BELTS - STANDARD PACK**  
**BANDAS ABRASIVAS - EN PAQUETE ESTÁNDAR**

CODE CÓDIGO	 mm x mm	GRAIN GRANO	PIECES NR. PIEZAS N°	FOR ART. PARA ART.
3.23.99.20	100x1000	50	10	510 - 511-293N-294N
3.23.99.21	100x1000	80	10	
3.23.99.22	120x1500	40	10	542B - 543B-504B - 534B - 535B - 536B - 502 - 503 - 504
3.23.99.23	120x1500	60	10	
3.23.99.24	120x1500	80	10	
3.23.99.25	150x1750	40	10	
3.23.99.26	150x1750	60	10	505B - 507B - 537B - 539B
3.23.99.27	150x1750	80	10	

**SANDING BELTS - STANDARD PACK**  
**BANDAS ABRASIVAS - EN PAQUETE ESTÁNDAR**

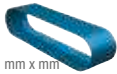
CODE CÓDIGO	 mm x mm	GRAIN GRANO	PIECES NR. PIEZAS N°	FOR ART. PARA ART.
3.23.99.36	100x1000	60	3	293N - 294N
3.23.99.37	75x2000	60	3	574 - 575
3.23.99.38	150x2000	60	3	577

**SANDING DISK - STANDARD PACK / DISCOS ABRASIVOS - EN PAQUETE ESTÁNDAR**

CODE CÓDIGO		GRAIN GRANO	PIECES NR. PIEZAS N°	FOR ART. PARA ART.
3.23.99.31	Ø 400 mm	40	10	537B - 539B - 525B
3.23.99.32	Ø 400 mm	60	10	
3.23.99.33	Ø 400 mm	80	10	

**ADAPTERS FOR WELCRO DISK / ADAPTADORES PARA DISCOS VELCRO**

3.23.75.09	For disk - Para discos Ø 350 mm
3.23.75.10	For disk - Para discos Ø 400 mm



GREAT PERFORMANCES LINE / LÍNEA DE ALTAS PRESTACIONES Ø 305

**305 PRO**

**168x78**



**PAG. 68**

Global versatility for the everyday job  
Versatilidad total para el trabajo diario

**305S**

**170x78**



**PAG. 70**

The strength for tradition  
La fuerza por tradición

**999 EVO**

**165x100**



**PAG. 67**

Energy and power in 18 kgs  
Energía y potencia en 18 kg

ALU LINE / LÍNEA DE ALU Ø 305



**XXX EVO ALU**

**170x70**

Once more, one step ahead!  
Otra vez, otro paso hacia el futuro!

**PAG. 73**



GREAT PERFORMANCES LINE / LÍNEA DE ALTAS PRESTACIONES Ø 305

**911 EVO**

**165x100**



**PAG. 66**

Outstanding leading performances  
Prestaciones líderes

**XXX EVO**

**170x70**

**PAG. 65**



VIDEO

Once more, one step ahead!  
Otra vez, otro paso hacia el futuro!



VIDEO

**1050 3D**

**305x90**



**PAG. 64**



PORTABLE LINE / LÍNEA DE FÁCIL TRANSPORTE Ø 250÷280

**732**

L MAX H MAX

**162x78**



**PAG. 72**

The indispensable  
La indispensable

**733**

L MAX H MAX

**162x75**



**PAG. 72**

Silent and reliable  
Silenciosa y fiable

**280S**

**150x70**



**PAG. 71**

Really unique  
Realmente única

**XPANDER**

Parquet cutter  
Corta parquet

**PAG. 69**



VIDEO

**IB500**

Edge bander  
Encoladora de cantos



**PAG. 75**



VIDEO

# 1050 3D

ART.	CODE / CÓDIGO
1050 3D	8.43.50.27

**PATENTED**

## TECHNICAL FEATURES

**Three combined functions:**  
**Mitresaw with upper table, sliding compound mitresaw, bench circular saw.**

- Maximum cutting capacity on the upper table: 60 mm! (only with blade protection mounted)
- Cutting angles 60° right and 50° left with automatic locking device  
 0° - 15° - 22,50° - 30° - 45°
- Patented change function system from mitresaw to circular saw easy and quick
- Telescopic sliding bars Ø 30 mm

## STANDARD EQUIPMENT

- Side extensions for big cuttings
- Vertical clamp for clamping of cutting material
- Blade protection for cutting on the upper table
- Key set / wood pusher

## CARACTERÍSTICAS TÉCNICAS

**Tres funciones combinadas: Corte inferior, corte superior y corte longitudinal telescópico**

- Corte en la mesa superior maxima: 60 mm! (sólo con protección de disco montada)
- Ángulo de corte 60° derecha y 50° izquierda, con dispositivo de bloqueo automático a  
 0° - 15° - 22,5° - 30° - 45°
- Sistema patentado de cambio de función de tronzadora a tronzadora de disco, rápido y fácil
- Barras de desplazamiento radial Ø 30 mm

## EQUIPAMIENTO DE SERIE

- Extensiones laterales para cortes de grandes dimensiones
- Morzada vertical para el bloqueo de la pieza
- Protección de disco para cortes en la mesa superior
- Llaves en dotación / accesorio para empujar la madera



Ø 305 mm

**LASER**



## CUTTING CAPACITY / CAPACIDAD DE CORTE

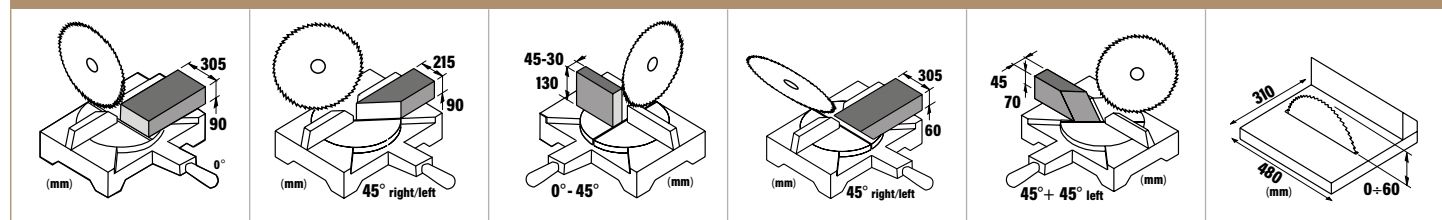

1800 W	3600 RPM	D305 -d30	990x650x460	28 Kg	90 mm	305 mm

230 Volt - Hz 50 single-phase motor / Motor monofásico 230 Volt - Hz 50

# XXX EVO

ART.	CODE / CÓDIGO
XXX EVO	8.43.60.45



## TECHNICAL FEATURES

- Movements on bearings of the turning table, head and joint
- Powerful 1500 Watt induction motor
- Piece support with sliding kit (INCLUDED)
- New T.P.S. (Three Positions System) handle (Patented)
- Micrometric adjustment of the upper working table

## STANDARD EQUIPMENT

- Chrome coated blade with Widia inserts and noise dampening-slots with key set.
- Vertical clamp
- Adjustable bar stop-rod for mass-produced cuts.
- Supplementary protection and wood pusher
- Sliding Kit

## CARACTERÍSTICAS TÉCNICAS

- Movimientos sobre cojinetes de la mesa giratoria, cabeza y articulación
- Motor de inducción silencioso y potente 1500 Watt
- Apoyo de la pieza con kit deslize incluido
- Nueva empuñadura TPS (Three Position System) (Patentado)
- Regulación micrométrica de la mesa superior de trabajo

## EQUIPAMIENTO DE SERIE

- Hoja con inserciones en Widia cromada y con hendiduras silenciadoras con liaves
- Mordaza vertical
- Varilla de sujeción de la barra para realizar cortes en serie
- Protección adicional y dispositivo de empuje madera
- Kit de deslizamiento



Piece support with sliding kit (INCLUDED)  
Apoyo de la pieza con kit de deslizamiento incluido

## PATENTED T.P.S. THREE POSITIONS SYSTEM



## CUTTING CAPACITY / CAPACIDAD DE CORTE

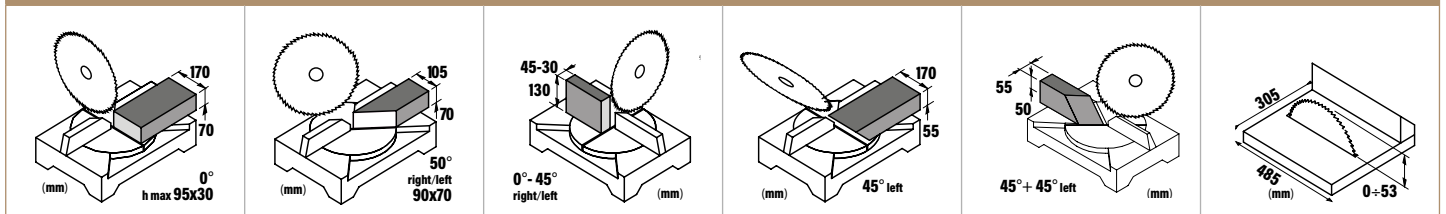

1500 W	2850	D305 - d30	630x630x500	24 Kg	70 mm	170 mm
--------	------	------------	-------------	-------	-------	--------

230 Volt - Hz 50 single-phase motor / Motor monofásico 230 Volt - Hz 50

# 911 EVO

ART.	CODE / CÓDIGO
911 evo	8.43.60.47

## TECHNICAL FEATURES

- Large upper working table (305x503 mm) with micrometric height adjustment
- Aluminium section upper table straightedge adjustable in two positions and with dual front and rear fixing system
- Silent and more powerful 1600 Watt induction motor with thermal protection
- Silent and reliable "POLY-V" belt transmission
- Base with integrated release lever protection

## STANDARD EQUIPMENT

- Chromed blade with Widia inserts
- Additional sliding pieces support
- Adjustable bar stop-rod for mass-produced cuts
- Supplementary protection and wood pusher and key set
- Vertical clamp

## CARACTERÍSTICAS TÉCNICAS

- Mesa de trabajo superior de grandes dimensiones (305x503 mm) con regulación micrométrica de la altura
- Regla superior de perfil de aluminio con regulación en 2 posiciones y con sistema de fijación doble (delantera y trasera)
- Motor de inducción silencioso y potente 1600 W con protección térmica
- Transmisión de correa "POLY-V" silenciosa y segura
- Base con protección integrada de la palanca para el desbloqueo

## EQUIPAMIENTO DE SERIE

- Disco con inserciones en Widia cromada
- Varilla de sujeción de la barra para realizar cortes en serie
- Llaves en dotación
- Protección adicional y dispositivo de empuje madera
- Kit de deslizamiento
- Mordaza vertical

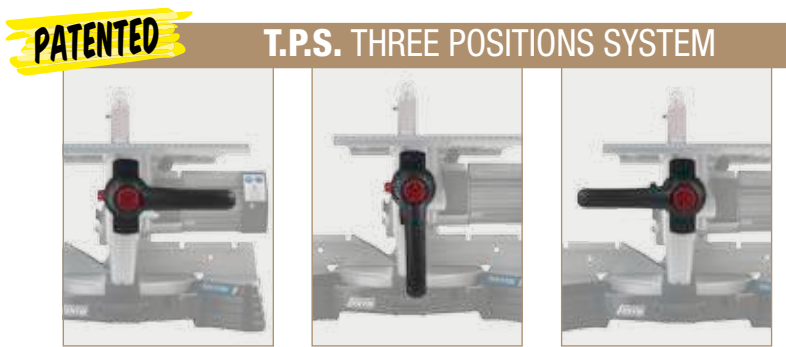

## CUTTING CAPACITY / CAPACIDAD DE CORTE

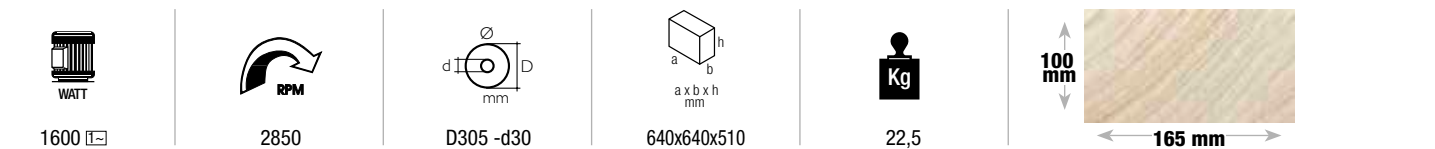
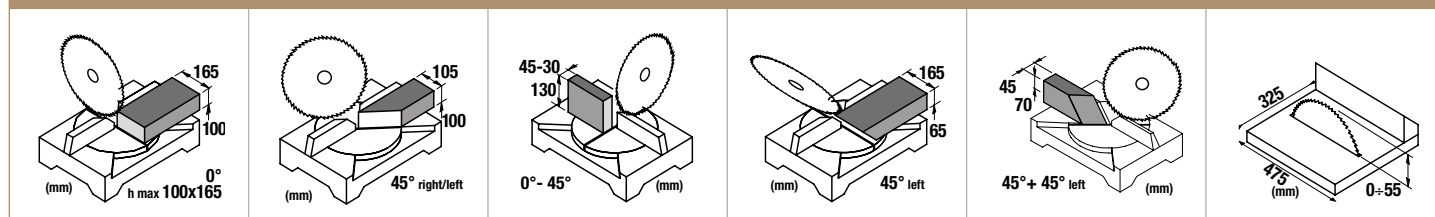

☑ 230 Volt - Hz 50 single-phase motor / Motor monofásico 230 Volt - Hz 50

## 999 EVO

ART.	CODE / CÓDIGO
999 EVO	8.43.60.43

## TECHNICAL FEATURES

- Aluminium section upper table straightedge adjustable in two positions and with dual front and rear fixing system
- Large upper working table (305x503 mm) with micrometric height adjustment
- Electronic control of the anti-reset safety function
- Base with integrated release lever protection with mechanical end-run limit
- Double mitre cut 45°+45° left

## STANDARD EQUIPMENT

- Chromed blade with Widia inserts
- Pieces support with sliding KIT (included)
- Adjustable bar stop-rod for mass-produced cuts
- Supplementary protection and wood pusher
- Vertical clamp

## CARACTERÍSTICAS TÉCNICAS

- Regla superior de perfil de aluminio con regulación en 2 posiciones y con sistema de fijación doble (delantera y trasera)
- Mesa de trabajo superior de grandes dimensiones (305x503 mm) con regulación micrométrica de la altura
- Control electrónico del sistema de seguridad anti-arranque
- Base con protección integrada de la palanca para el desbloqueo con fin de carrera
- Corte combinado 45°+45° izquierda

## EQUIPAMIENTO DE SERIE

- Disco cromado con inserciones en Widia
- Apoyo de la pieza con kit e deslizamiento incluido
- Varilla de sujeción de la barra para realizar cortes en serie
- Protección adicional y accesorio para empujar la madera
- Mordaza vertical



Powerful universal motor 1700 watt

Potente motor universal 1700 W

Ø 305 mm

Piece support with sliding kit (INCLUDED)  
Apoyo de la pieza con kit de deslizamiento incluido

**PATENTED**

T.P.S. THREE POSITIONS SYSTEM



## CUTTING CAPACITY / CAPACIDAD DE CORTE

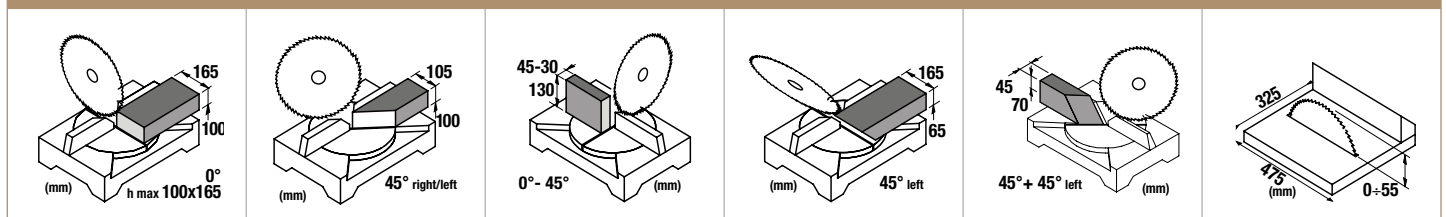

1700



4200



D305 -d30



640x640x510



18



230 Volt - Hz 50 single-phase motor / Motor monofásico 230 Volt - Hz 50

# 305 PRO

ART.	CODE / CÓDIGO
305 PRO	8.43.60.44

## TECHNICAL FEATURES

- Powerful 1300 Watt induction motor
- Base suitable for Sliding Kit (OPTIONAL)
- T.P.S. (Three Positions System) handle (Patented)
- Upper table in aluminium extrusion with lateral extension (OPTIONAL - see pag 73)
- Base with integrated release lever protection with mechanical end stroke

## STANDARD EQUIPMENT

- Chrome coated blade with Widia inserts and noise dampening-slots with key set
- Vertical clamp
- Supplementary protection and wood pusher

## CARACTERÍSTICAS TÉCNICAS

- Potente motor de inducción 1300 W
- Mesa de trabajo con predisposición para el kit de deslizamiento (OPCIONAL)
- Empunadura TPS (Three Positions System) (Patentado)
- Mesa superior de trabajo de extrusión con extensión lateral (OPCIONAL - Ver página 73)
- Base con y protección integrada de la palanca para el desbloqueo con fin de carera

## EQUIPAMIENTO DE SERIE

- Hoja con inserciones en Widia cromada y con hendiduras silenciadoras con liaves
- Mordaza vertical
- Protección adicional y dispositivo de empuje madera



**PATENTED**

**T.P.S. THREE POSITIONS SYSTEM**

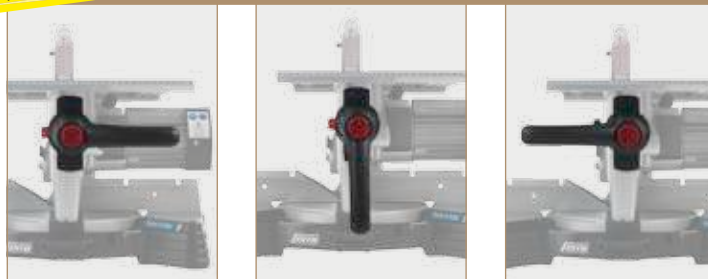

## CUTTING CAPACITY / CAPACIDAD DE CORTE

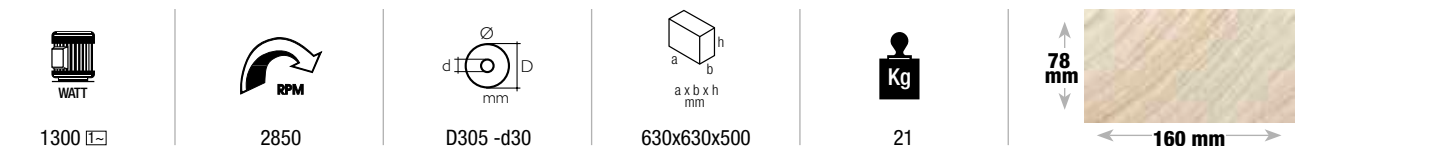
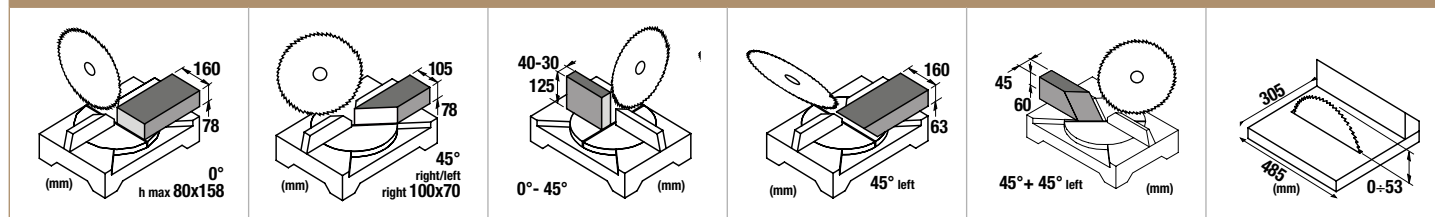

□ 230 Volt - Hz 50 single-phase motor / Motor monofásico 230 Volt - Hz 50

# X PANDER



ART.	CODE / CÓDIGO
XPANDER	7.07.50.76



VIDEO

## TECHNICAL FEATURES

- Made in aluminium, it increases the cutting capacity up to 30%
- It allows compound cuts up to 48° to compensate walls out of square
- Designed for the application of both the horizontal clamp and the vertical clamp
- Easy and fast assembling on the machine thanks to 2 fast fixing points
- Exclusive and patented design

## CARACTERÍSTICAS TÉCNICAS

- En aluminio, mayor capacidad de corte hasta el 30%
- Ángulo de corte regulable hasta 48° para el ajuste de las paredes exteriores
- Predisposición para el uso de la mordaza horizontal y vertical
- Montaje fácil y rápido del accesorio sobre la máquina por medio de 2 puntos de montaje rápido
- Diseño exclusivo y patentado



## CUTTING CAPACITY / CAPACIDAD DE CORTE

		Cut at 0°/Corte a 0°	Cut at 45°/Corte a 45°
XXX EVO XXX EVO ALU	Ø 305	200 mm × h 10 mm	130 mm × h 10 mm
305 PRO	Ø 305	205 mm × h 10 mm	140 mm × h 10 mm
911 EVO	Ø 305	210 mm × h 10 mm	142 mm × h 10 mm
999 EVO	Ø 305	210 mm × h 10 mm	142 mm × h 10 mm



L max 210 mm  
H max 10 mm

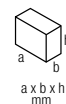

500x230x90



3

## 305 S

ART.	CODE / CÓDIGO
305 S	8.43.80.22

## TECHNICAL FEATURES

- Very sturdy and robust structure: great reliability and cutting precision
- Movement of the turning table entirely on bearings
- Head return system protected with anti-fall spring
- Sheet metal frontal blade protection
- Silent 1400W induction motor
- Cutting angle adjustable from 0° to 45° right and left

## STANDARD EQUIPMENT

- Blade with Widia inserts
- Adjustable bar stop-rod for mass-produced cuts
- Key set
- Supplementary protection and wood pusher

## CARACTERÍSTICAS TÉCNICAS

- Estructura muy sólida y rígida: gran fiabilidad y precisión de corte
- Movimientos de la mesa giratoria enteramente sobre cojinetes
- Sistema de retorno de la cabeza con muelle anti-caída
- Cáster de corte frontal en chapa laminada
- Motor de inducción silencioso 1400 Watt
- Ángulo de corte regulable de 0° a 45° izquierda Y derecha

## EQUIPAMIENTO DE SERIE

- Disco con inserciones en Widia
- Varilla de sujeción de la barra para realizar cortes en serie
- Llaves en dotación
- Protección adicional y accesorio para empujar la madera



- Great precision and cutting capacity (170 mm x 78 mm)
- Gran precisión y capacidad de corte (170 mm x 78 mm)



- Upper working table 475 mm x 325 mm with 66 mm cutting height
- Mesa superior 475 mm x 325 mm con capacidad de corte 66 mm

## CUTTING CAPACITY / CAPACIDAD DE CORTE

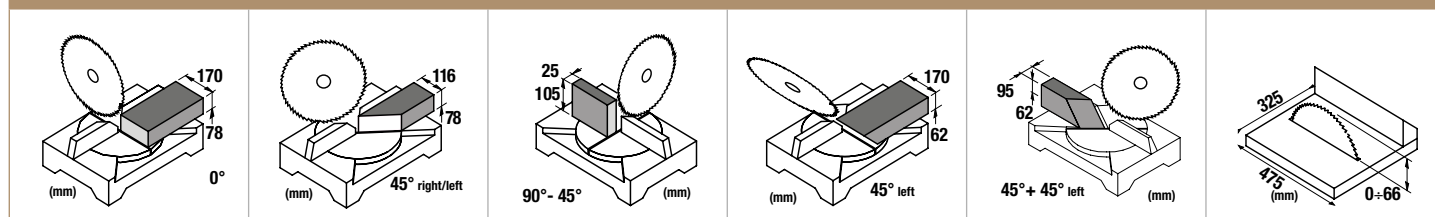

1400 WATT



3000 RPM



D305 -d30 mm



640x640x510 mm



29 Kg



78 mm



170 mm

□ 230 Volt - Hz 50 single-phase motor / Motor monofásico 230 Volt - Hz 50



# 280 S

ART.	CODE / CÓDIGO
280 S	8.42.80.21

### TECHNICAL FEATURES

- The only mitresaw in the world with Ø 280 mm blade
- Movement of the turning table entirely on bearings
- Great cutting performances 150 x 70 mm
- Silent 1300W induction motor
- Ideal handle for ground working
- 2-positions upper work table cutting guide
- Double mitre cut 45°+45° left

### STANDARD EQUIPMENT

- Blade with Widia inserts for the maximum material penetration
- Adjustable bar stop-rod for mass-produced cuts
- Key set
- Supplementary protection and wood pusher

### CARACTERÍSTICAS TÉCNICAS

- La única tronzadora en el mundo con disco Ø 280 mm
- Movimientos de la mesa giratoria enteramente sobre cojinetes
- Grandes prestaciones de corte 150 x 70 mm
- Motor de inducción silencioso 1300 W
- Empuñadura ideal para trabajos en tierra
- Guía corte mesa superior de dos posiciones
- Corte combinado 45°+45° izquierda

### EQUIPAMIENTO DE SERIE

- Disco con inserciones en Widia para la máxima penetración en el material
- Varilla de sujeción de la barra para realizar cortes en serie
- Llaves en dotación
- Protección adicional y accesorio para empujar la madera



- Cutting angle adjustable from 0° to 45° right and left
- Ángulo de corte regulable de 0° a 45° izquierda y derecha



- Sturdy and robust structure for a great cutting precision
- Estructura sólida y rígida para una gran precisión de corte

### CUTTING CAPACITY / CAPACIDAD DE CORTE

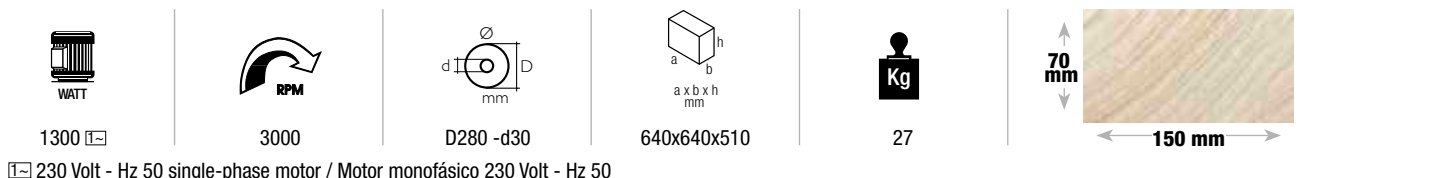
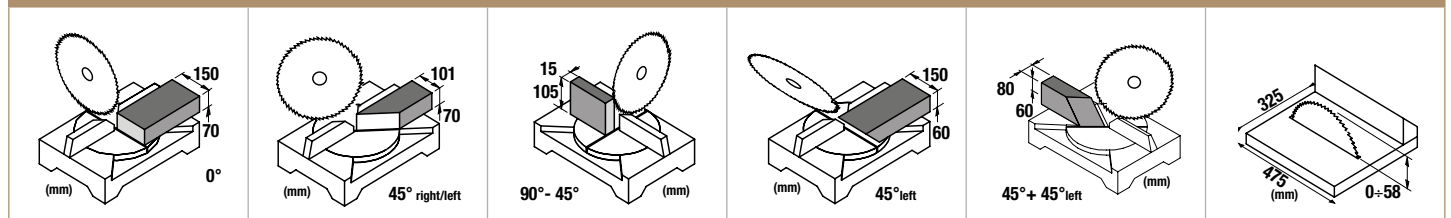

☑ 230 Volt - Hz 50 single-phase motor / Motor monofásico 230 Volt - Hz 50

# 732 / 733

ART.	CODE / CÓDIGO
732	8.42.00.28

## 732



### TECHNICAL FEATURES

- Die cast aluminium body
- Cutting capacity 162 mm!
- Powerful universal motor 1550 Watt
- Double mitre cut 45°+ 45° left
- Upper table 360x462 mm

### STANDARD EQUIPMENT







- Blade with Widia inserts
- Adjustable bar stop-rod for massproduced cuts
- Supplementary protection and wood pusher and key set
- Vertical clamp

### CARACTERÍSTICAS TÉCNICAS

- Estructura de aluminio fundido a presión
- Capacidad de corte 162 mm!
- Potente motor universal 1550 W
- Corte combinado 45° + 45° izquierda
- Mesa superior provista de guía, con altura regulable (360x462 mm)

### EQUIPAMIENTO DE SERIE

- Disco con inserciones de Widia
- Varilla de sujeción de la barra
- Protección adicional y accesorio para empujar la madera y llaves
- Mordaza vertical

 WATT	 RPM	 mm	 a x b x h mm	 Kg	 H max mm	 L max mm
1550	4200	D254 -d30	530x535x390	14,5	78	162

⚡ 230 Volt - Hz 50 single-phase motor / Motor monofásico 230 Volt - Hz 50

### CUTTING CAPACITY / CAPACIDAD DE CORTE

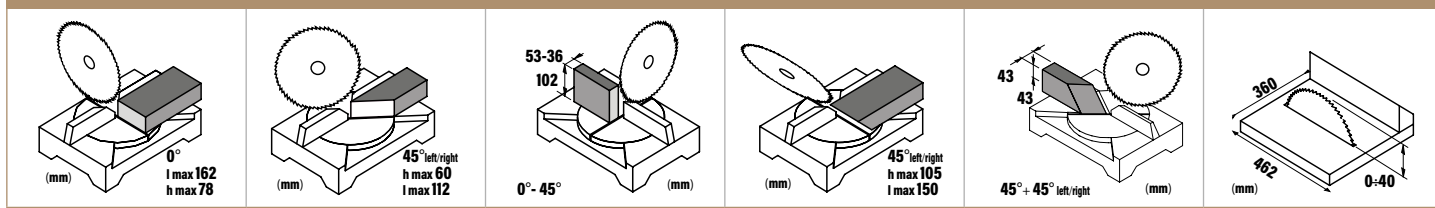

ART.	CODE / CÓDIGO
733	8.42.00.29

## 733



### TECHNICAL FEATURES

- Die cast aluminium body
- Cutting capacity 162 mm!
- Silent and powerful induction motor 1300 W
- Upper table 360x462 mm!!
- Adjustable cutting angle from 0° to 47° right and left

### STANDARD EQUIPMENT







- Blade with Widia inserts
- Key set
- Adjustable bar stop-rod for massproduced cuts
- Supplementary protection and wood pusher
- Vertical clamp

### CARACTERÍSTICAS TÉCNICAS

- Estructura de aluminio fundido a presión
- Capacidad de corte 162 mm!
- Motor de inducción 1300 W silencioso y potente
- Mesa superior provista de guía, con altura regulable (360x462 mm)
- Ángulo de corte regulable de 0° a 47° derecha e izquierda

### EQUIPAMIENTO DE SERIE

- Disco con inserciones de Widia para la máxima penetración en el material
- Llaves en dotación
- Varilla de sujeción de la barra
- Protección adicional y accesorio para empujar la madera
- Mordaza vertical

 WATT	 RPM	 mm	 a x b x h mm	 Kg	 H max mm	 L max mm
1300	2850	D254 -d30	530x535x390	17,5	75	162

⚡ 230 Volt - Hz 50 single-phase motor / Motor monofásico 230 Volt - Hz 50

### CUTTING CAPACITY / CAPACIDAD DE CORTE

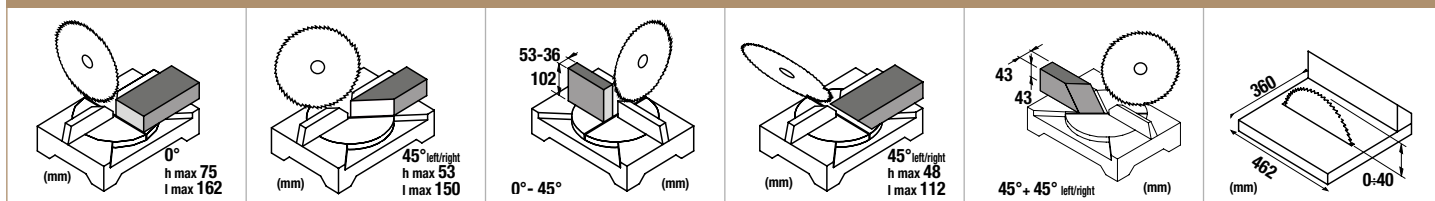

# XXX EVO ALU

ART.	CODE / CÓDIGO
XXX EVO ALU	8.43.60.46

## TECHNICAL FEATURES

- New T.P.S. (Three Position System) handle (PATENTED)
- Movements on bearings of the turning table, head and joint
- Powerful 1500 Watt silent induction motor
- Piece support with sliding kit (INCLUDED)

## STANDARD EQUIPMENT

- Chrome coated blade with Widia inserts and noise dampening-slot
- Vertical clamp
- Adjustable bar stop-rod for mass-produced cuts
- Sliding kit

## CARACTERÍSTICAS TÉCNICAS

- Nueva empuñadura TPS (Three Position System) (PATENTADO)
- Movimientos sobre cojinetes de la mesa giratoria, cabeza y articulación
- Motor de inducción silencioso y potente 1500 Watt
- Apoyo de la pieza con kit de deslize incluido

## EQUIPAMIENTO DE SERIE

- Hoja con inserciones en Widia cromada y con hendiduras silenciadoras
- Mordaza vertical
- Varilla de sujeción de la barra para realizar cortes en serie
- Kit de deslizamiento



- Vertical clamp included
- Mordaza vertical incluida



- Special Z84 blade for alu
- Disco Especial Z84 para aluminio

**PATENTED**

**T.P.S. THREE POSITIONS SYSTEM**



## CUTTING CAPACITY / CAPACIDAD DE CORTE

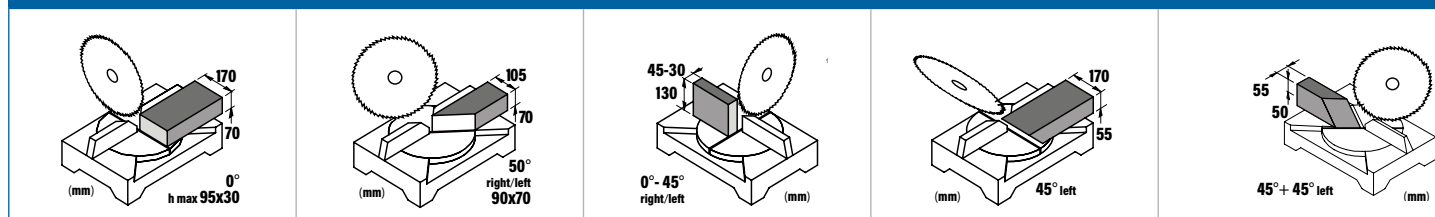

1500 W



2850



D305 -d30



630x630x500



21,5





70 mm

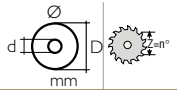

170 mm

⚡ 230 Volt - Hz 50 single-phase motor / Motor monofásico 230 Volt - Hz 50

CODE CÓDIGO			USES USOS	FOR ART. PARA ART.		
<b>BLADES FOR WOOD AND PLASTIC MATERIALS / DISCOS PARA MADERA Y MATERIAS PLÁSTICAS</b>						
<b>3.27.85.26</b>	250x30	<b>24</b>	2,5	Shredding and ripping of: soft woods, hard woods, solid woods. Troceado y corte a lo largo de la veta de: maderas blandas, duras y macizas.	<b>842*</b>	
<b>3.27.85.28</b>	250x30	<b>40*</b>	2,5	Shredding and ripping of: soft woods, hard woods, solid woods. Troceado y corte a lo largo de la veta de: maderas blandas, duras y macizas.		
<b>3.27.85.07</b>	250x30	<b>60</b>	2,5	Ripping and crosscutting of: soft and hard woods, solid and exotic woods, chipboard and stratified panels. Corte a lo largo y a través de la veta de: maderas blandas, exóticas, aglomerada y paneles estratificados.		
<b>3.27.85.08</b>	250x30	<b>80</b>	3,2	Ripping and crosscutting of: soft and hard woods, solid and exotic woods, chipboard and stratified panels. Crosscutting of: chipboard, thermoplastic, MDF, laminated on one side. Trimming of: wooden frames, skirting board, excellent quality woods. Corte a lo largo y a través de la veta de: maderas blandas, duras, macizas, exóticas, aglomerada y paneles estratificados. Corte a través de la veta de: madera aglomerada, termoplásticos, MDF, laminados sobre una sola cara. Acabado de: marcos, listones y maderas preciosas.		
<b>3.27.85.39</b>	254x30	<b>24*</b>	2,5	Shredding and ripping of: soft woods, hard woods, solid woods. Troceado y corte a lo largo de la veta de: maderas blandas, duras y macizas.		<b>732*-733</b>
<b>3.27.85.40</b>	254x30	<b>40*</b>	2,5	Shredding and ripping of: soft woods, hard woods, solid woods. Troceado y corte a lo largo de la veta de: maderas blandas, duras y macizas.		<b>732-733*</b>
<b>3.27.85.29</b>	300x30	<b>48</b>	2,5	Shredding and ripping of: soft woods, hard woods, solid woods. Troceado y corte a lo largo de la veta de: maderas blandas, duras y macizas.		<b>846 300 SPECIAL</b>
<b>3.27.85.13</b>	300x30	<b>72</b>	3,2	Ripping and crosscutting of: soft and hard woods, solid and exotic woods, chipboard and stratified panels. Corte a lo largo y a través de la veta de: maderas blandas, duras, macizas, exóticas, aglomerada y paneles estratificados.		
<b>3.27.85.14</b>	300x30	<b>96</b>	3,2	Ripping and crosscutting of: soft and hard woods, solid and exotic woods, chipboard and stratified panels. Crosscutting of: chipboard, thermoplastic, MDF, laminated on one side. Trimming of: wooden frames, skirting board, excellent quality woods. Corte a lo largo y a través de la veta de: maderas blandas, duras, macizas, exóticas, aglomerada y paneles estratificados. Corte a través de la veta de: madera aglomerada, termoplásticos, MDF, laminados sobre una sola cara. Acabado de: marcos, listones y maderas preciosas.		
<b>3.27.85.31</b>	305x30	<b>48*</b>	2,5	Shredding and ripping of: soft woods, hard woods, solid woods. Troceado y corte a lo largo de la veta de: maderas blandas, duras y macizas.		
<b>3.27.99.51</b>	305x30	<b>72</b>	3,0	Ripping and crosscutting of: soft and hard woods, solid and exotic woods, chipboard and stratified panels. Corte a lo largo y a través de la veta de: maderas blandas, duras, macizas, exóticas, aglomerada y paneles estratificados.	<b>XXX EVO* 305 PRO* 911 EVO* 999 EVO* 305S* 10503D*</b>	
<b>3.27.99.52</b>	305x30	<b>96</b>	3,2	Ripping and crosscutting of: soft and hard woods, solid and exotic woods, chipboard and stratified panels. Crosscutting of: chipboard, thermoplastic, MDF, laminated on one side. Trimming of: wooden frames, skirting board, excellent quality woods. Corte a lo largo y a través de la veta de: maderas blandas, duras, macizas, exóticas, aglomerada y paneles estratificados. Corte a través de la veta de: madera aglomerada, termoplásticos, MDF, laminados sobre una sola cara. Acabado de: marcos, listones y maderas preciosas.		

\*Standard fitting / En dotación estándar

<b>BLADES FOR ALUMINIUM / DISCOS PARA ALUMINIO</b>					
3.27.85.09	250x30	<b>80</b>	3,2	Cutting of: aluminium sections and extrusions. Tronzado de: elementos perfilados y extrusionados de aluminio y metales no ferrosos.	<b>842</b>
3.27.85.41	254x30	<b>80</b>	3,2	Cutting of: aluminium sections and extrusions. Tronzado de: elementos perfilados y extrusionados de aluminio y metales no ferrosos.	<b>732-733</b>
3.29.00.09	280x30	<b>64</b>	3,0	Cutting of: aluminium sections and extrusions. Tronzado de: elementos perfilados y extrusionados de aluminio y metales no ferrosos.	<b>280S</b>
3.27.85.21	300x30	<b>84</b>	3,0	Cutting of: aluminium sections and extrusions. Tronzado de: elementos perfilados y extrusionados de aluminio y metales no ferrosos.	<b>846 Alu 846 300 SPECIAL</b>
3.27.85.15	300x30	<b>96</b>	3,0	Cutting of: aluminium sections and extrusions. Tronzado de: elementos perfilados y extrusionados de aluminio y metales no ferrosos.	
3.27.99.53	305x30	<b>84*</b>	3,0	Cutting of: aluminium sections and extrusions. Tronzado de: elementos perfilados y extrusionados de aluminio y metales no ferrosos.	<b>XXX EVO 305 PRO 911 EVO-999 EVO XXX EVO XXX EVO Alu* 305S</b>
3.27.99.54	305x30	<b>96</b>	3,0	Cutting of: aluminium sections and extrusions. Tronzado de: elementos perfilados y extrusionados de aluminio y metales no ferrosos.	

\*Standard fitting / En dotación estándar

## IB 500

ART.	CODE / CÓDIGO
IB 500	8.62.01.26

## TECHNICAL FEATURES

- Solid metal sheet frame, adjustable support feet for the maximum stability
- Hot air flow - 2 speeds: 18-30 m<sup>3</sup>/h
- Adjustable heating temperature from 350°C to 500°C
- Folding outrigger support

## EDGE BANDING SYSTEM

- Designed for hot-melt adhesives edge banding materials higher no more than 48 mm
- Ideal for finishing linear and moulded panels

## •CARACTERÍSTICAS TÉCNICAS

- Estructura robusta, con patas de nivelación ajustables para un trabajo en máxima estabilidad
- Flujo de calor 2 velocidades: 18-30 m<sup>3</sup>/h
- Temperatura de calentamiento ajustable desde 350°C hasta 500°C
- Soporte para el rodillo de sujeción plegable

## ENCOLADORA DE CANTOS

- Para el pegado por calor de rollos de altura máxima 48 mm
- Ideal para el acabado de paneles lineales y perfilados



VIDEO



- Double edge guide max H 48 mm and edge cutting knob
- Doble guía de la banda max H 48 mm y cizalla para el corte de borde



- Stable steel metal work table 682 x 191 mm
- Mesa de trabajo estable 682 x 191 mm



- Working table extension for curved surfaces
- Extensión de la mesa de trabajo para el tratamiento de superficies curvas



2000



18-30



Ø max 48 mm



350°- 500°



12

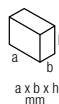

730x420x255

# STANDY



ART.	CODE / CÓDIGO
390	7.13.36.87

### TECHNICAL FEATURES

- Sturdy stoved painted steel structure
  - Pre-arranged to be fixed on the floor
  - Maximum charge 150 kg
- ### CARACTERÍSTICAS TÉCNICAS
- Robusta estructura de acero pintada en caliente
  - Está adaptada para ser fijada al piso
  - Max posibilidad de carga: 150 kg

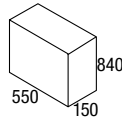

### WOOD SUPPORT FOR FIXING MITERSAWS TO THE COLUMN (INCLUDED)

BASE DE FIJACIÓN DE MADERA INCLUIDA



### UNIVERSAL COLUMN FOR MITERSAWS BASE EXPOSITORA UNIVERSAL PARA TRONZADORAS DE MADERA

ART.	CODE CÓDIGO	FOR ART. PARA ART.	Kg
390	7.13.36.87	All the mitersaws Todas las tronadoras	15

# JOBBY

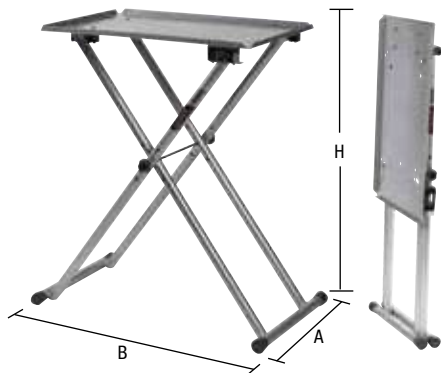

ART.	CODE / CÓDIGO
300 PLUS	7.13.36.48

### TECHNICAL FEATURES

- Foldable for easy handling
- Sturdy steel section structure
- Height adjustable in three positions

### CARACTERÍSTICAS TÉCNICAS

- Plegable para un fácil transporte
- Estructura de perfil de acero robusto
- Altura regulable en tres posiciones



Safety system against accidental locking  
Sistema de seguridad contra un cierre accidental

FOLDING TABLE "JOBBY" / BANCO PLEGABLE "JOBBY"	
SIZE axbxh / DIMENSIONES axbxh	FOR ART. / PARA ART.
650x420x740/820/870	All the mitersaws Todas las tronadoras

# MULTY



ART.	CODE / CÓDIGO
360	7.13.36.47

### TECHNICAL FEATURES

- Sturdy solid aluminium structure
- Universal couple of brackets for the bandsaw and mitersaw fixing
- Possibility to electrically connect three tools
- Integrated handle for an easy transport
- Side supports extensible, height and width adjustable
- Maximum charge: 120 kg

### CARACTERÍSTICAS TÉCNICAS

- Robusta estructura en perfilado de aluminio
- Par de abrazaderas universales para fijar tronadoras y SIERRA de cinta
- Posibilidad de conectar eléctricamente hasta 3 aparatos
- Empuñadura integrada para un fácil transporte
- Apoyos laterales extensibles, regulables en alto y ancho
- Max posibilidad de carga: 120 kg

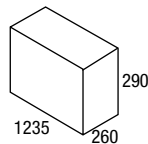

FOLDING TABLE "MULTY" / BANCO PLEGABLE "MULTY"	
FOR ART. PARA ART.	Kg
All the mitersaws / Todas las tronadoras	20



Kit of brackets for quick fixing.  
Kit de abrazaderas para fijado rápido



Additional kit on demand  
Kit adicional bajo pedido

CODE / CÓDIGO
7.13.06.58



**SLIDING KIT / KIT DE DESLIZE**

CODE / CÓDIGO	FOR ART. / PARA ART.
<b>7.07.50.36</b>	911 EVO - 999 EVO XXX EVO - XXX EVO ALU - 305 PRO



**CLAMPS / MORDAZAS UNIVERSALES**

CODE / CÓDIGO	FOR ART. / PARA ART.
<b>7.13.05.57 - Frontal/Horizontal</b>	305S - 280S - 732 - 733
<b>7.13.07.01 - Vertical/Vertical</b>	XXX EVO -305 PRO - 911 - 999 EVO XXX EVO ALU - 846 - 846 ALU - 300 SPECIAL - 842
<b>7.13.06.07 - Frontal/Horizontal</b>	XXX EVO - XXX EVO ALU
<b>7.13.06.41 - Frontal/Horizontal</b>	305 PRO - 911 - 999 - 846 - 846 ALU 300 SPECIAL - 842

**Lateral extension of the upper table**

- Lateral extension in aluminium extrusion
- Accurate and steady fixing
- Increases the upper table dimensions from 305mm x 485 mm to 455mm x 485mm

**Extensión lateral de la mesa superiores**

- Extensión lateral en extrusion de aluminio
- Fijación precisa y estable
- Aumenta el tamaño de la mesa superior de 305mm x 485 mm asta 455mm x 485mm

**LATERAL EXTENSION / EXTENSIÓN LATERAL**

CODE / CÓDIGO	FOR ART. / PARA ART.
<b>7.07.50.77</b>	911 EVO - 999 EVO - XXX EVO - 305 PRO

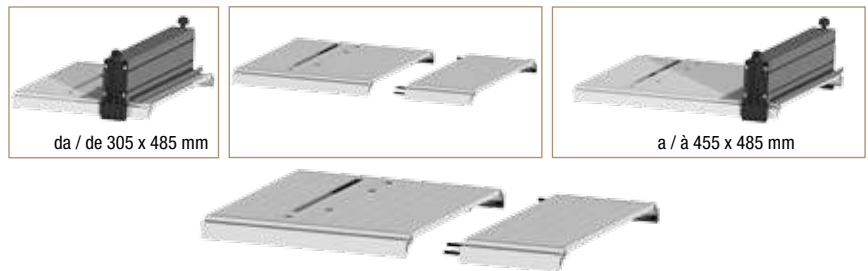

**SINGLE-ROLLER SUPPORT / SOPORTE MONO-RODILLO**

ART.	CODE / CÓDIGO	SIZE / DIMENSIONES AxBxH (mm)	WEIGHT / PESO
<b>301</b>	<b>7.13.37.16</b>	520x400x680÷1140	6,5 kg

**TECHNICAL FEATURES**

- Zinc-plated steel roller Ø 57 mm
- Sturdy steel structure
- Base equipped with leveling feet
- Support height adjustment
- Maximum charge: 30 kg

**CARACTERÍSTICAS TÉCNICAS**

- Rodillo de acero galvanizado Ø 57 mm
- Robusta estructura de acero, hierro fundido
- Base provista de pies de nivelación
- Regulación de la altura de apoyo
- Max posibilidad de carga: 30 kg

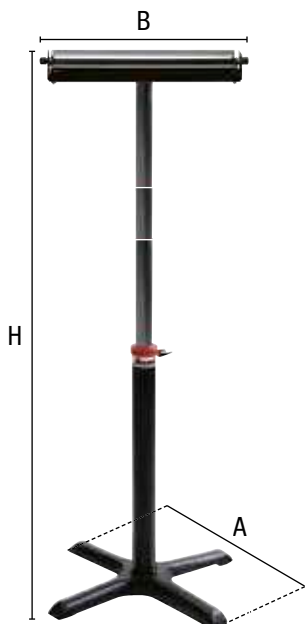

**GRADUATED GONIOMETER | GONIÓMETRO GRADUADO**

CODE / CÓDIGO	ANGLE REG. / REG. ÁNGULO	FOR ART. / PARA ART.
<b>5.13.07.68</b>	0° - 60° left-right	GOLD-XXX2-911-999-846-300 SPECIAL-842



**DUST COLLECTION BAG / BOLSA DE RECOGIDA DE VIRUTAS**

CODE / CÓDIGO	FOR ART. / PARA ART.
<b>7.07.50.32</b>	All the mitresaws / Todas las tronzadoras

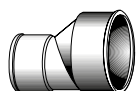

**MITRESAW DUST COLLECTOR ADAPTER / ADAPTADOR ASPIRACION PARA TRONZADORAS**

CODE / CÓDIGO	Ø REDUCTION / Ø REDUCCIÓN	Ø MITRESAW COUPLING / Ø ACOPLER TRONZADORA	FOR ART. / PARA ART.
<b>5.06.10.44</b>	100 mm	40 mm	305 PRO / 999 EVO / 911 EVO XXX EVO / XXX EVO ALU

# DISPLAYS



## DCS DISPLAY

CODE / CÓDIGO 0.00.08.52

Weight / Peso: 4,7 kg

### Cardboard display for DCS NG110 bandsaw

Panel de cartón  
para sierra de cinta DCS NG110

DCS NG110 bandsaw not included  
DCS NG110 Sierra de cinta no incluidas

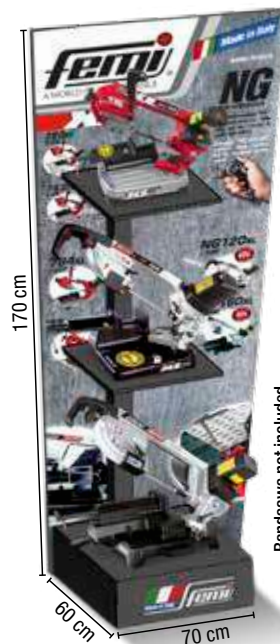

## METAL LINE LÍNEA METAL

### Metal display

Expositor metal

CODE / CÓDIGO 7.13.36.72

Weight / Peso: 30 kg

Maximum charge of each shelf: 30 kg.

Máxima posibilidad de carga de los estantes: 30 kg

Maximum charge of bottom base: 35 kg.

Máxima posibilidad de carga de la base: 35 kg

### Cardboard panel

Panel de cartón

CODE / CÓDIGO 7.13.36.74

Bandsaws not included  
Sierras de cinta no incluidas

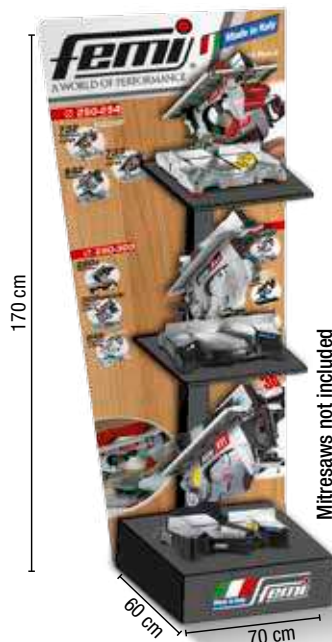

## WOOD LINE LÍNEA MADERA

### Metal display

Expositor metal

CODE / CÓDIGO 7.13.36.72

Weight / Peso: 30 kg

Maximum charge of each shelf: 30 kg.

Máxima posibilidad de carga de los estantes: 30 kg

Maximum charge of bottom base: 35 kg.

Máxima posibilidad de carga de la base: 35 kg

### Cardboard panel

Panel de cartón

CODE / CÓDIGO 7.13.36.69

Mitresaws not included  
Tronzadoras no incluidas



### Cardboard display for 787 xl allroad

Panel de cartón  
para 787 xl allroad

CODE / CÓDIGO 7.13.36.71

h. 180 cm

Weight / Peso: 1 kg

## BENCH GRINDERS ESMERILADORAS

### GRINDY

CODE / CÓDIGO 7.13.36.96

### Display column for bench grinders Base expositora para esmeriladoras

Weight / Peso: 13 kg

Display unit column in bended steel metal  
for displaying four bench grinders  
Maximum charge for each shelf: 25 kg  
(no limit charge for exposition on the base)

Base expositora de acero laminado y pensado para  
la exhibición de cuatro esmeriles de banco  
Maxima carga posible por cada piso: 25 kg (sin  
límite de peso sobre la base)

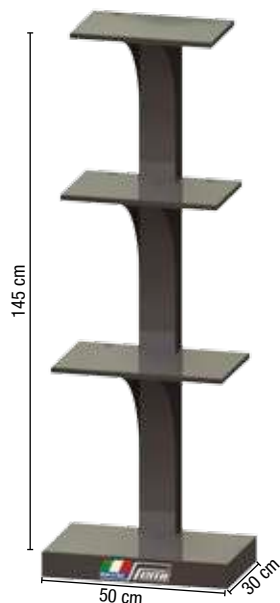



# TRY ME! DEMO KIT

**Cardboard display**  
Panel de cartón

**CODE / CÓDIGO 0.00.07.86**  
Weight / Peso: 3,8 kg



**Bandsaw not included**  
Sierra de cinta no incluida

190 cm



ART. 300  
"JOBBOY"

**Metal band saw spare blade**  
Hoja de cinta adicional



**Metal piece for cutting tests**  
Pieza de metal para pruebas de corte



**Flyers 16 x 23 cm**  
Folletos 16 x 23 cm



VIDEO

# SYMBOLS / SIMBOLOGIA



**Winding safety thermic protection**  
Protección térmica de seguridad de los bobinados



**Single-phase electric motor 230 V - 50 Hz**  
Motor eléctrico monofásico 230 V - Hz 50



**Three-phase electric motor at 1 or 2 speeds 400 V - 50 Hz**  
Motor eléctrico trifásico de 1 ó 2 velocidades 400 V - Hz 50



**Blade tensioning device with light indicator and safety microswitch**  
Tensor de la hoja con indicador luminoso y microinterruptor de seguridad



**CE certification: in compliance with EEC directives 2004/108 - 2006/42 - 2006/95**  
Certificación CE: conformidad con las directivas CEE 2004/108 - 2006/42 - 2006/95



**Digital electronically controlled constant speed**  
Velocidad constante con control electrónico digital



**Electronic speed adjustment**  
Regulación electrónica de la velocidad



**Two speeds, electronically switched**  
Dos velocidades con conmutación electrónica



**Two speeds, polar switched motor**  
Dos velocidades con conmutación polar del motor



**Dust collection system**  
Sistema de aspiración del polvo



**Double safety insulation**  
Doble aislamiento de seguridad



**Grit: the higher number corresponds to the finer grain**  
Granulometría: a un número más alto corresponde un grano más fino



**Ultra-low safety tension controls (24 Volt)**  
Mandos de seguridad de bajísima tensión (24 V)

**FEMI SpA reserves the right to make without prior notice all changes which may be necessary to improve the product.**

**The general descriptions, pictures and drawings are not binding but only indicative**

FEMI SpA se reserva el derecho a realizar cualquier cambio necesario para la mejora del producto, sin necesidad de previo aviso.

Las descripciones generales, imágenes o dibujos serán sólo indicativos y no vinculantes.





**FEMI SpA**

Via del Lavoro, 4  
40023 Castel Guelfo (BO) · ITALY  
Tel. +39 0542 487611  
infocom@femi.it

**[www.femi.it](http://www.femi.it)**



**FEMI France Sarl**

58, Avenue des Bruyères · 69150 Décines · FRANCE  
Tel. +33 (0) 4 - 78702778  
femifrance@femi.it

**[www.femi.it/fr](http://www.femi.it/fr)**